

garofalo

SEMPLICI IDEE D'ARREDO

MANUALE PER L'UTENTE

USER MANUAL | MODE D'EMPLOI | MANUAL DE USUARIO |
GEBRAUCHSANWEISUNG

TUSCANY 280

V49.07.001

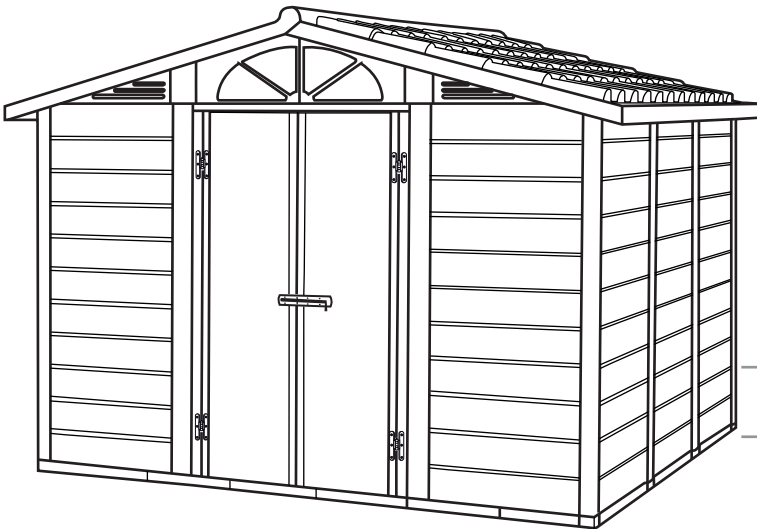

TUSCANY EVO 280

V50.07.001

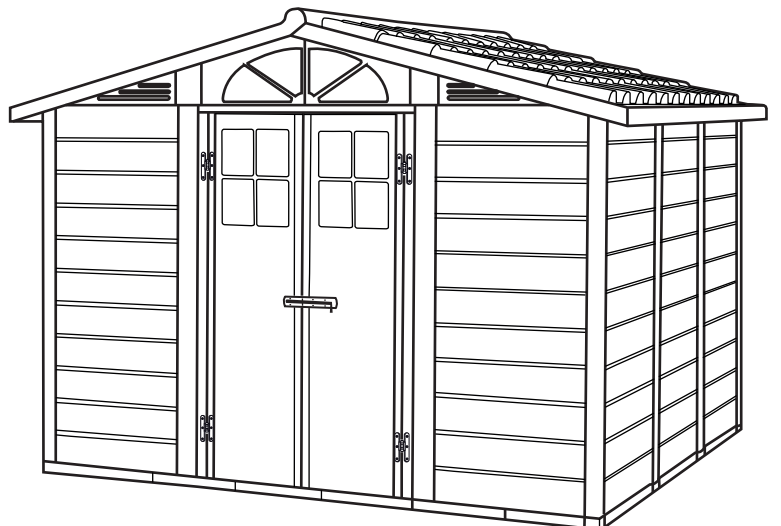

PREPARAZIONE DEL LUOGO DI MONTAGGIO | SITE PREPARATION | PRÉPARATION DU SITE | PREPARACIÓN DEL LUGAR | VORBEREITUNG DES AUFSTELLUNGORTES

Livella la superficie del terreno | Level the ground surface | Égalisez la surface du sol | Niveler la superficie del suelo | Ebenen Sie die Bodenoberfläche



Raccomandazione: costruisci una base di legno o di cemento come fondamenta

Recommendation: Construct a wooden or concrete base as a foundation |

Recommandation: fabriquez une base en bois ou

en béton en guise de fondation

| Recomendación: construya una base de madera o de cemento a modo de cimien

to | Empfehlung: Bauen Sie als Fundament eine Grundfläche aus Holz oder Beton

Opzione | option | option | opción | option

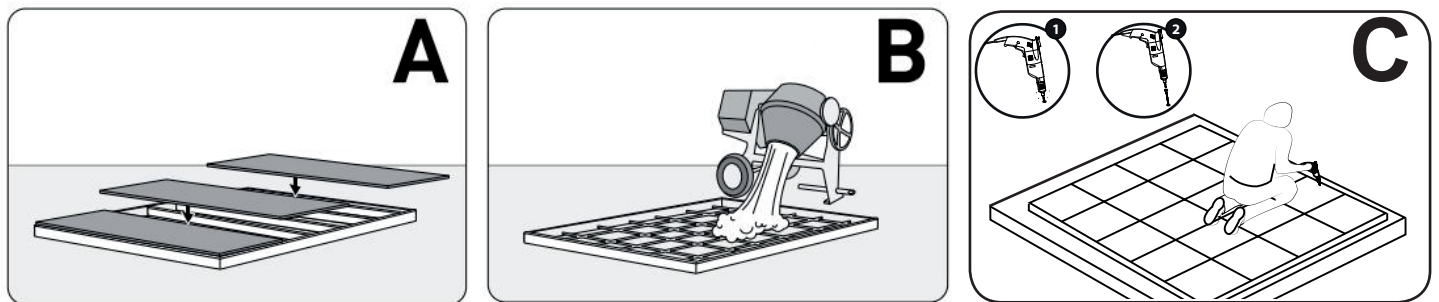

OPTION | OPTION | OPCIÓN | OPTION | OPTIE | OPZIONE | OPÇÃO

ASSICURARE LA COPERTURA ALLE FONDAMENTA

Fissa il deposito attrezzi alle fondamenta facendo dei fori nel pavimento ed avvitandolo alle fondamenta utilizzando apposite viti (viti non incluse).

SECURING THE SHED TO A FOUNDATION

Affix the shed to the foundation by drilling holes in the shed floor and screwing it into the foundation using appropriate screws (screws not included).

FIXER L'ABRI SUR UNE FONDATION

Fixez l'abri à la fondation en perçant des trous dans le sol et en insérant des vis adéquates dans la fondation (vis non fournies).

ASEGURAR EL COBERTIZO A UN CIMIENTO











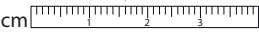
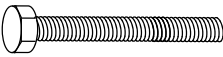
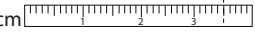

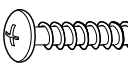
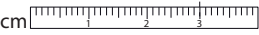
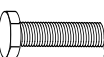
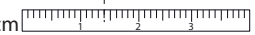

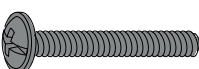
Fije el cobertizo a los cimientos perforando agujeros en el suelo del cobertizo y atornillelo a los cimientos utilizando los tornillos adecuados (los tornillos no están incluidos).

ABSICHERN DES SCHUPPENS AN EIN FUNDAMENT

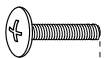
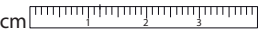
Bringen Sie den Schuppen auf dem Fundament an, in den Schuppenboden bohren und diesen mit passenden Schrauben auf dem Fundament festschrauben (Schrauben nicht enthalten).

TUSCANY / TUSCANY EVO 280

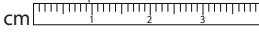
KIT VITERIA S01.50.172

 N - x24 4,5 x 16 	 V - x12 M6 x 35 	 RG - x40	 M6 - x18
 W - x122 5 x 30 	 Z - x6 M6 x 14 	 VP - x2	
 B - x30 M4 x 30 	 M4 - x30	 Tp - x72	
 Y - x28 M5 x 12 	 Tpd - x30	 R6 - x36	
 V - x12 2,9 x 9,5 	 M5f - x28	 R4 - 30x	

attrezzi da usare
 tools to use
 outils à utiliser
 Zu verwendendes Werkzeug
 Herramientas necesarias
 ferramentas a utilizar

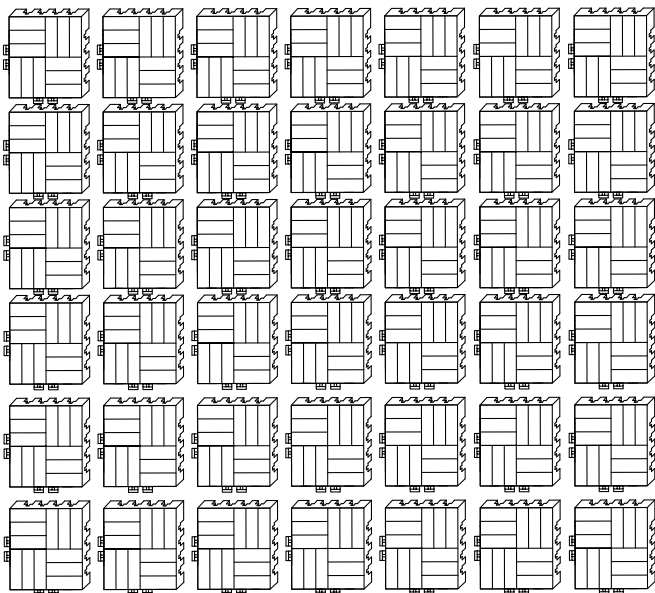
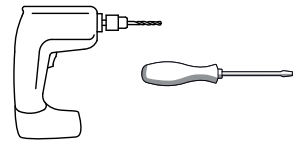

PAV 42x
 M02.10.014

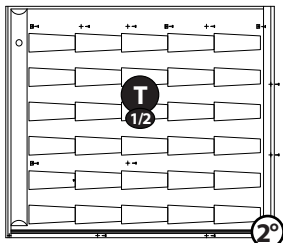

2x T-sx
M06.06.011

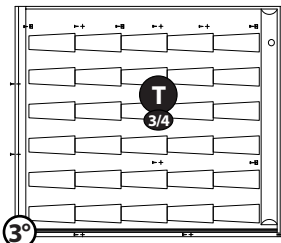

2x T-dx
M06.06.010

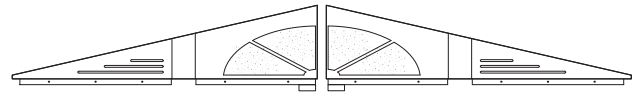
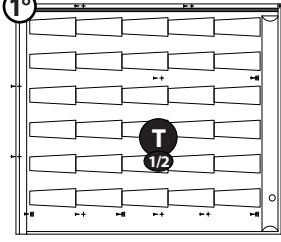
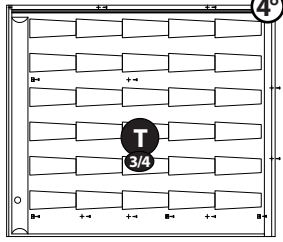

G
M06.06.021

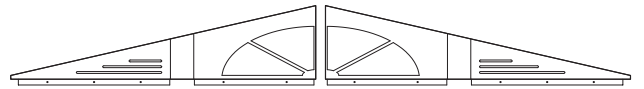

E
M06.06.022

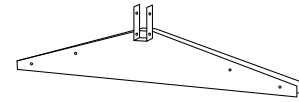

2x Z
M02.09.020

Tuscany

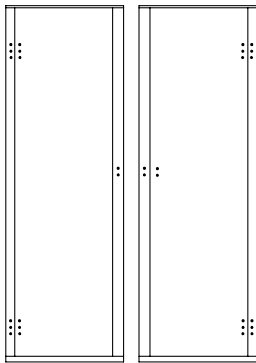

P-sx P-dx
S02.02.030 S02.02.029



2x K
M02.09.024

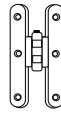

4x S
M02.09.001

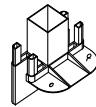

8x H
M02.05.006

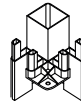

4x R
M02.05.007



U
M02.09.030

Tuscany Evo

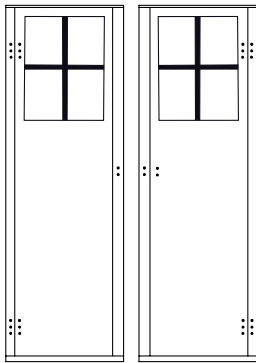

P-sx P-dx
S02.02.007 S02.02.006

1x KIT-M09.01.005



8x Q
M02.08.014



O
M05.09.002

1x KIT-M09.01.004



4x O
M02.08.006

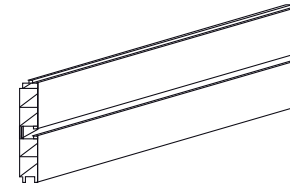

110x I
L 752 mm
S01.09.042

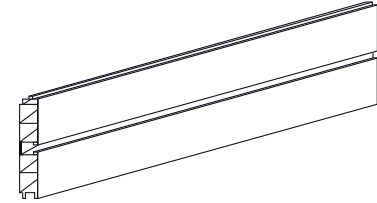

11x L
L 1164 mm
S01.09.043

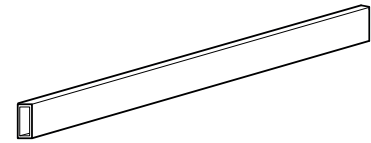

1x M
L 1164 mm
S02.03.048

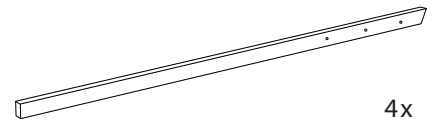

4x V
M02.09.023

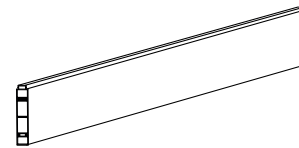

1x N
L 770 mm
S01.09.124

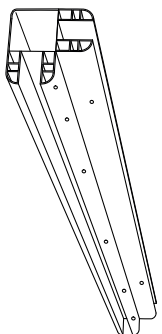

4x A

L 1765 mm
S01.09.038



2x B

L 1740 mm
S02.03.017

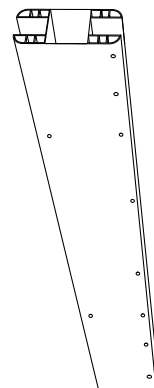

4x C

L 1975 mm
S01.09.035

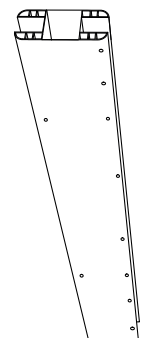

4x D

L 1765 mm
S01.09.034

1. ASSEMBLAGGIO PAVIMENTO | FLOOR ASSEMBLY | MONTAGE DU SOL | ARMADO DEL PISO | MONTAGE DER BODENPLATTE

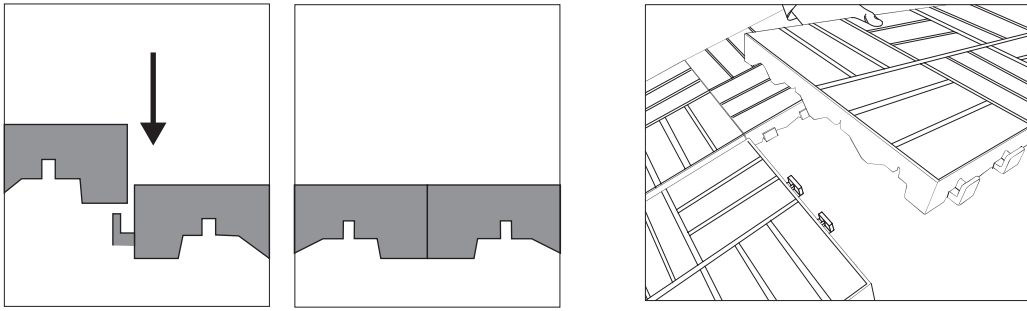

2.

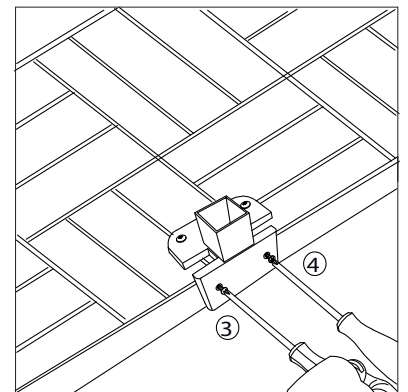
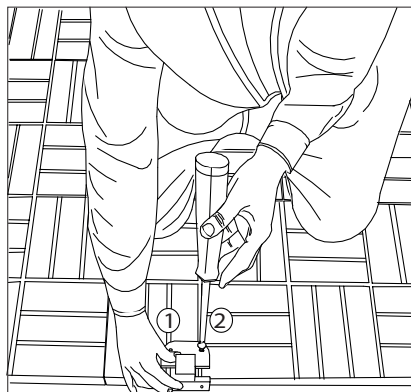
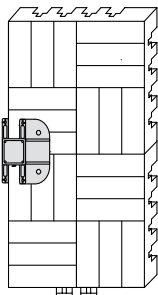
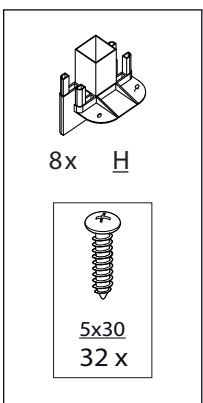
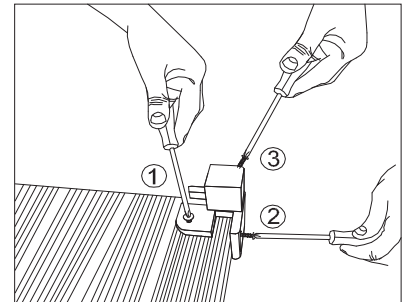
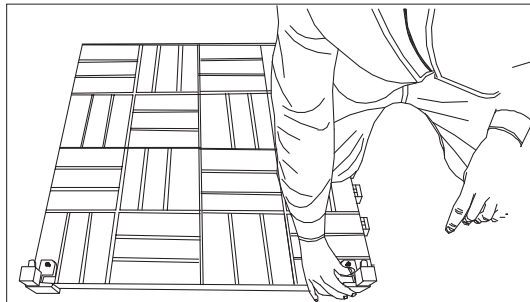
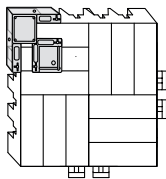
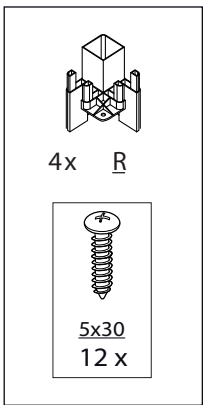
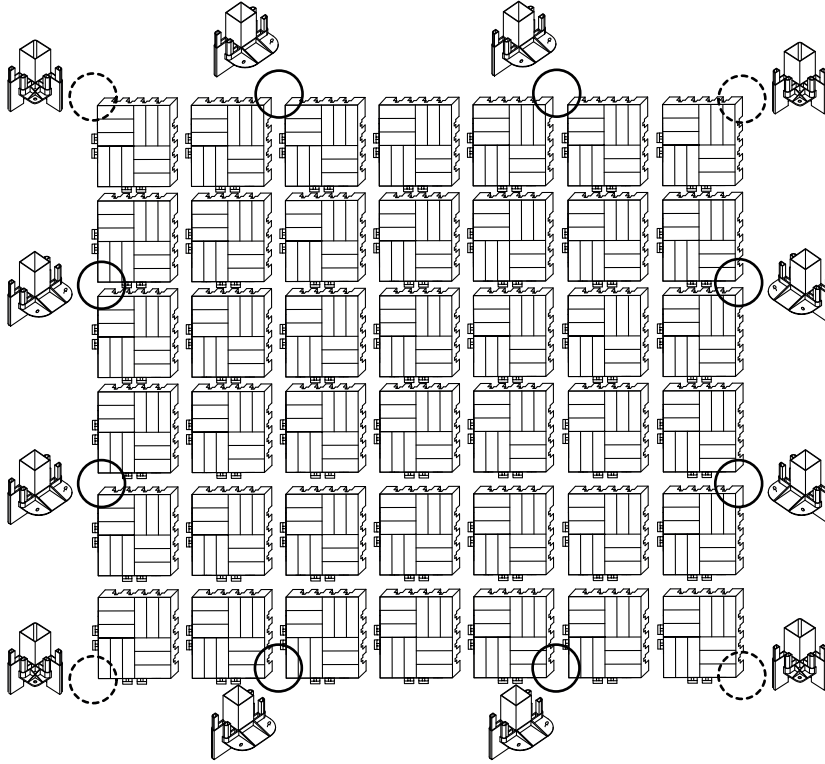

3. ASSEMBLAGGIO MURO | WALL ASSEMBLY | MONTAGE DU MUR | ARMADO DE PAREDES | MONTAGE DER WÄNDE

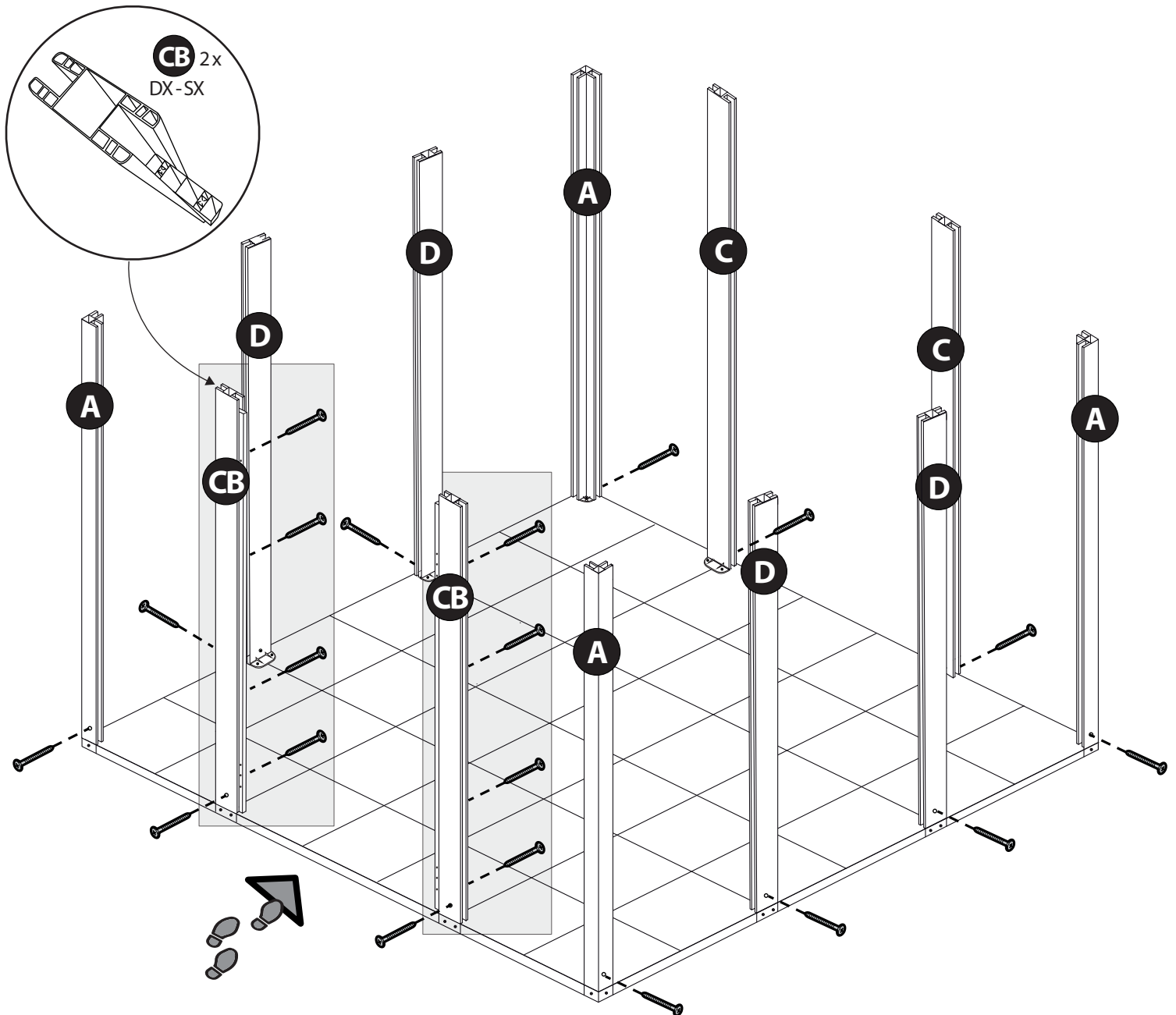
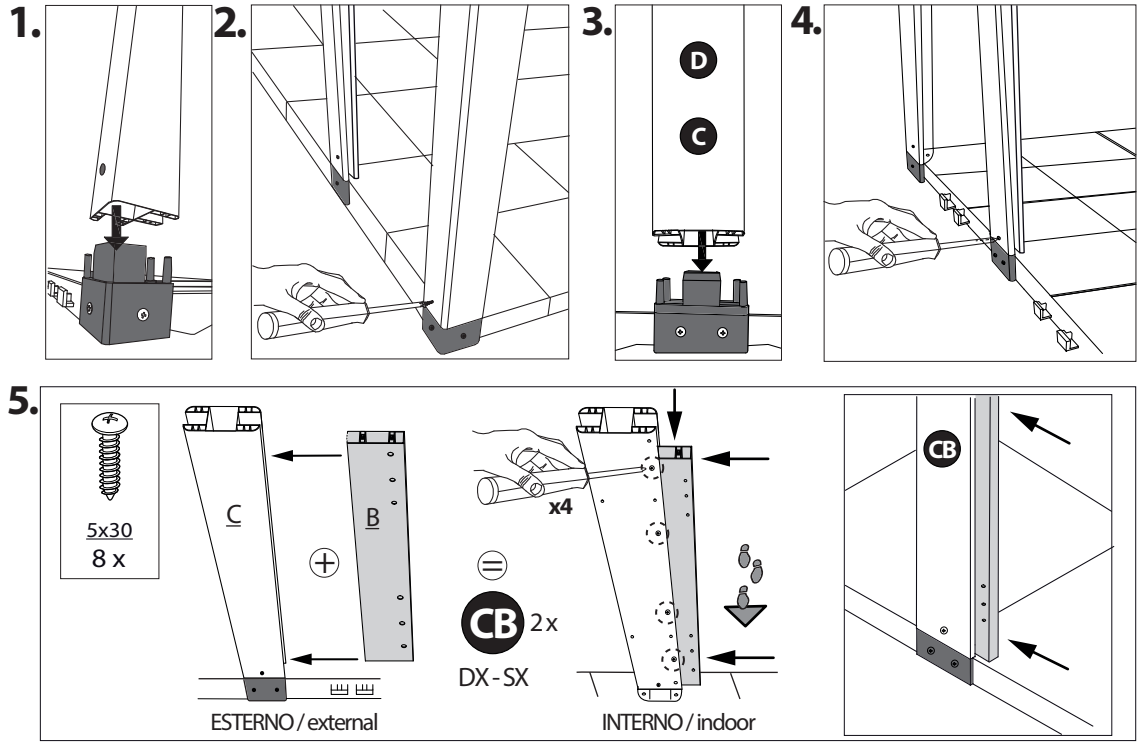
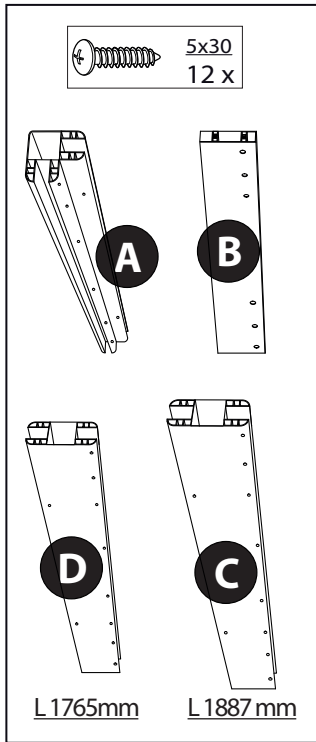

4.



ATTENZIONE! Incastrare bene le doghe.
ATTENTION! Make sure the profiles are pressed firmly down to make a tight joint.

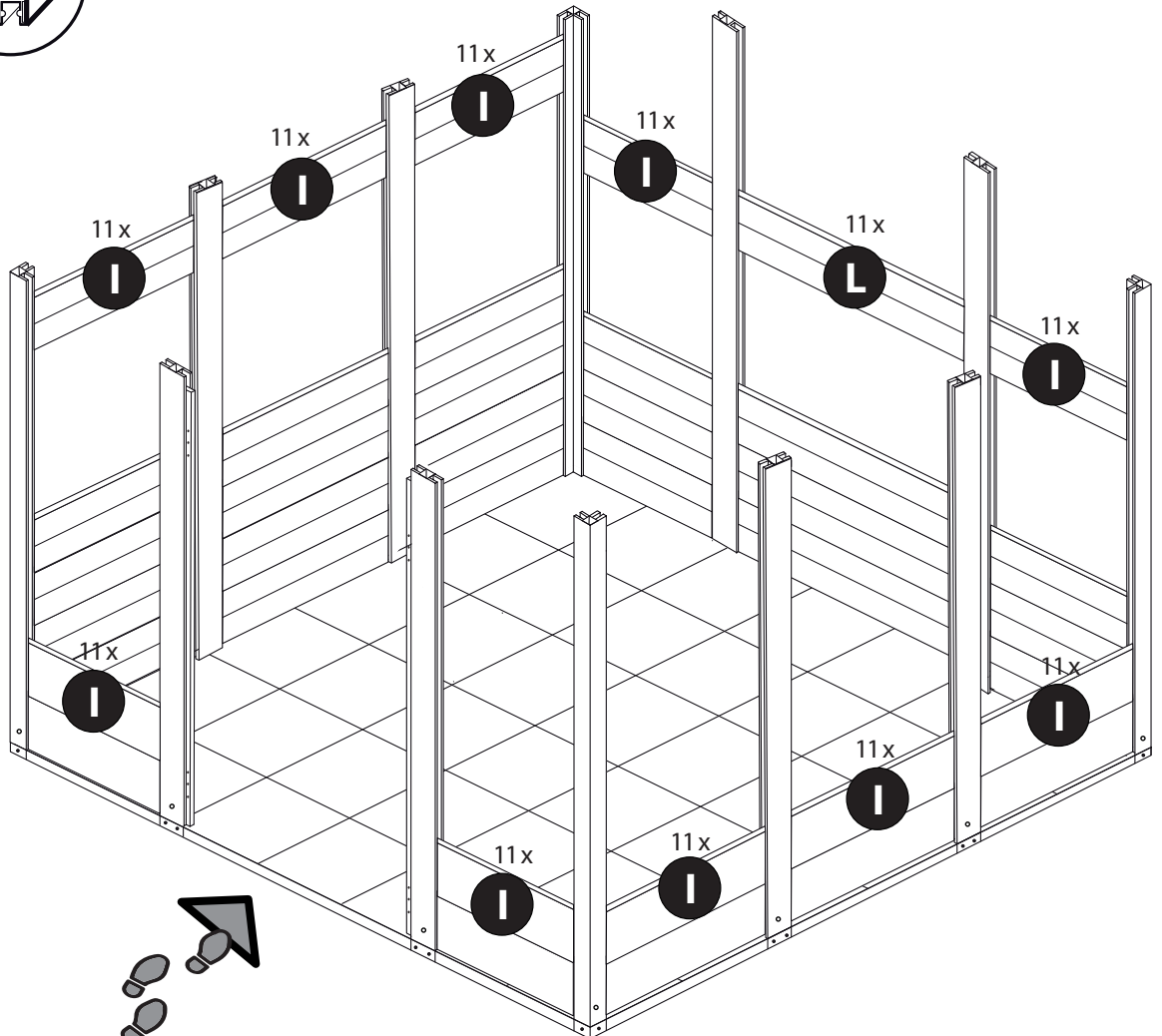
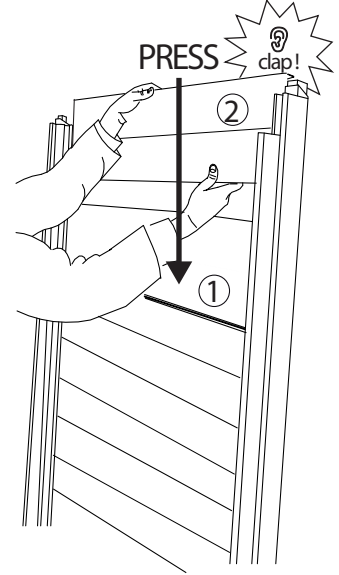
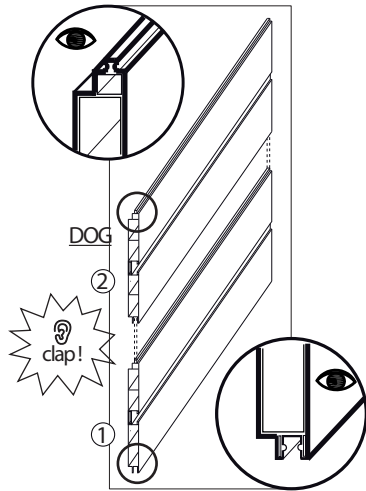
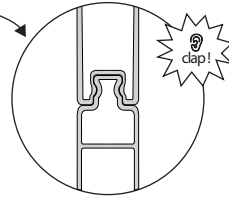
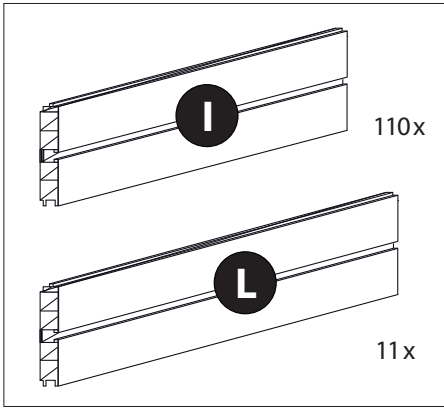

5.



ATTENZIONE!
Prima di avvitare, avvolgere e stringere la casetta con lo spago in dotazione.
ATTENTION!
Before screwing, wrapping and tightening the house with the supplied string.

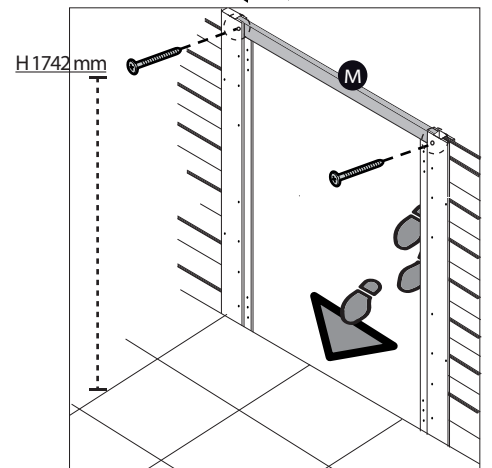
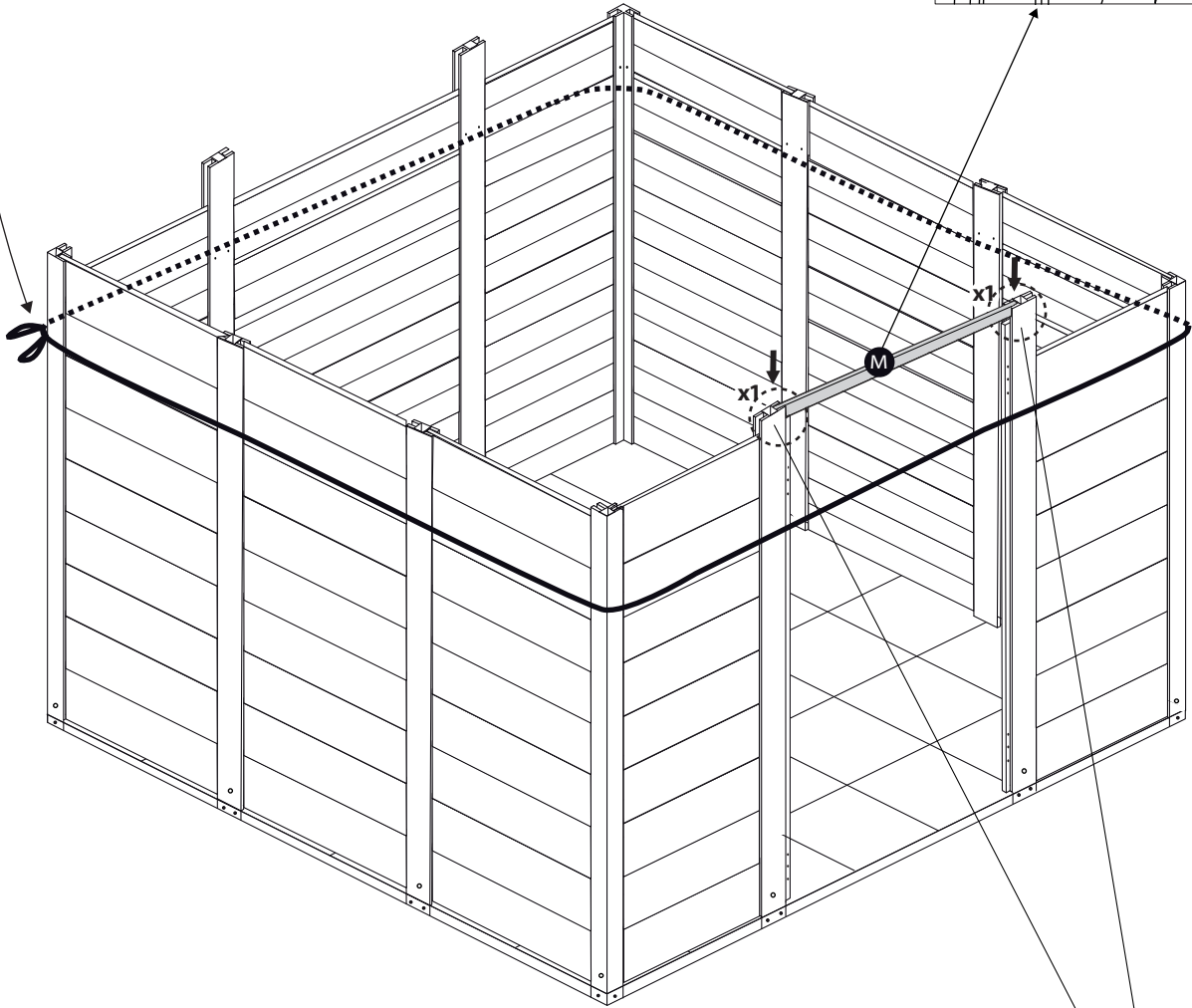

6.

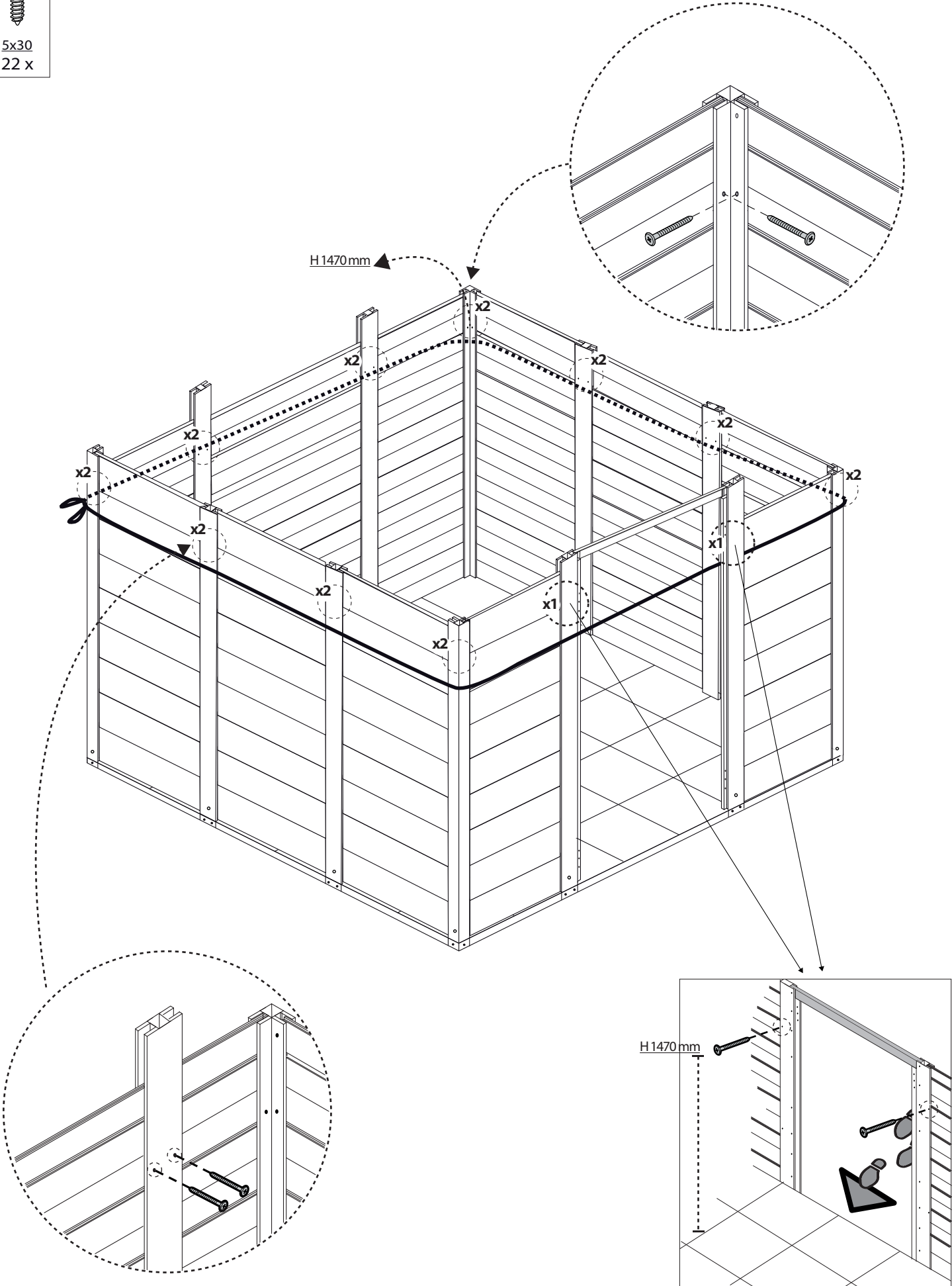

DX

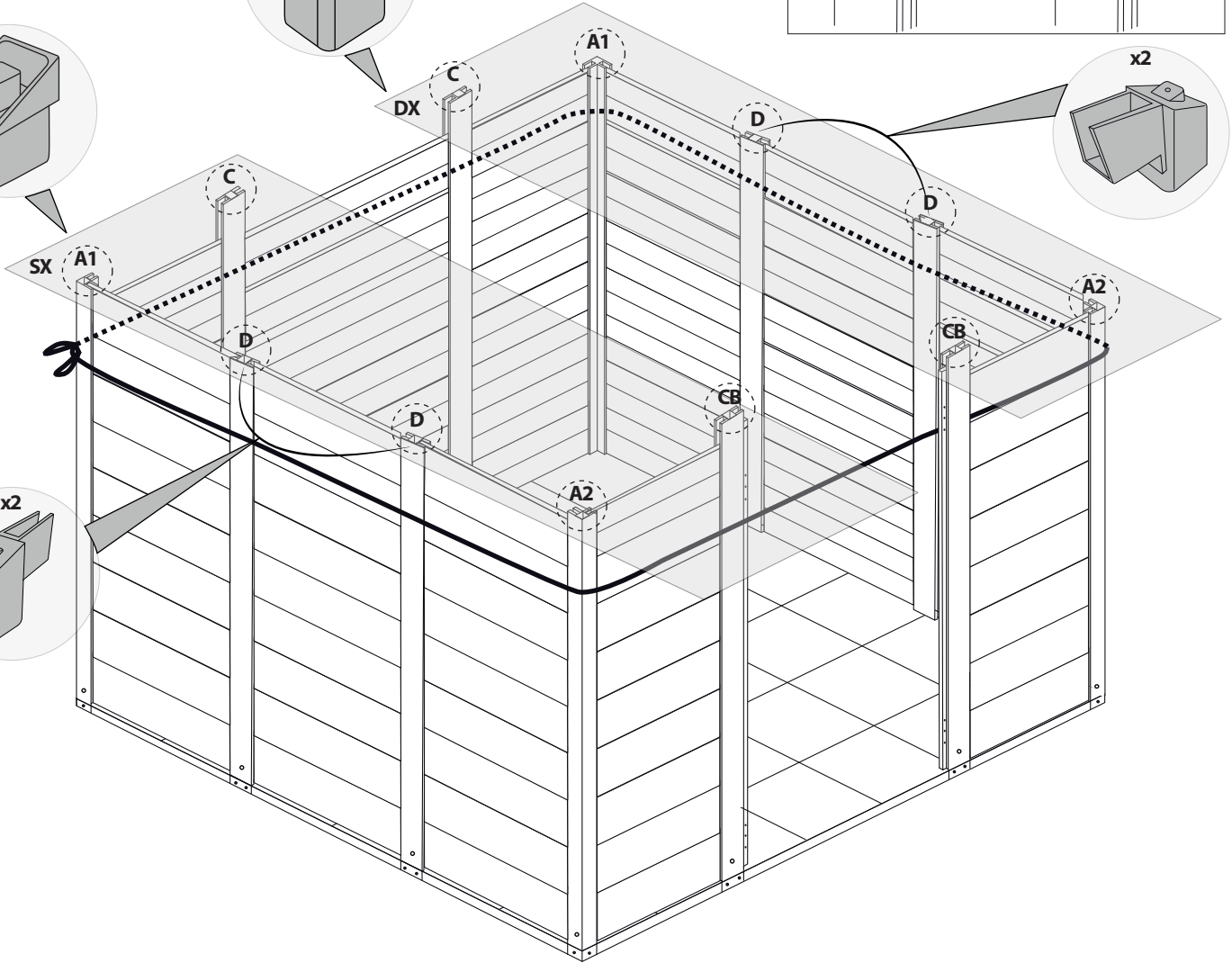
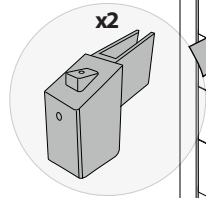
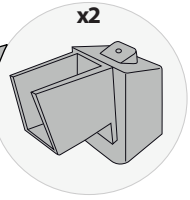
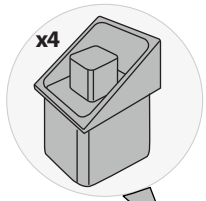
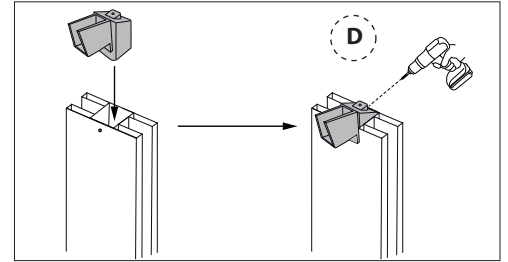
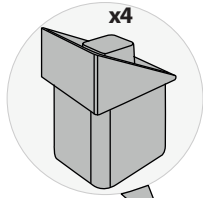
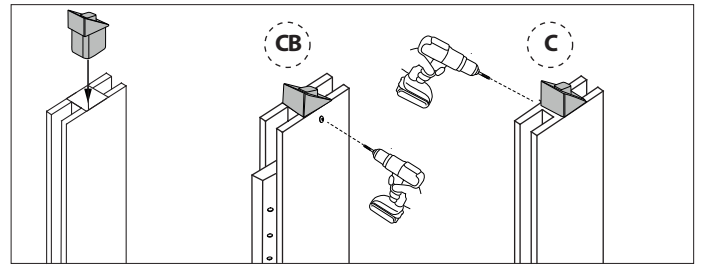
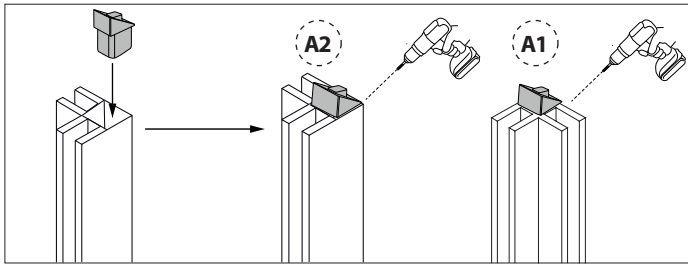

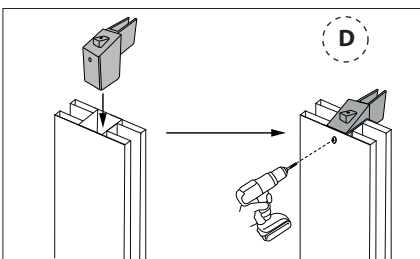
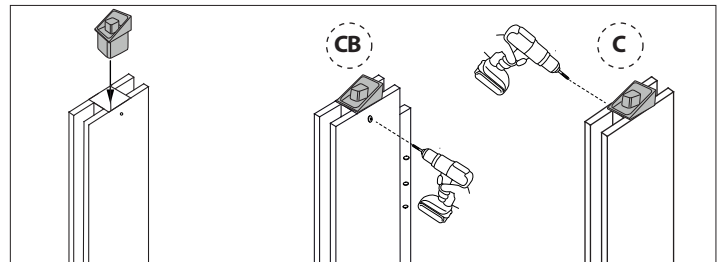
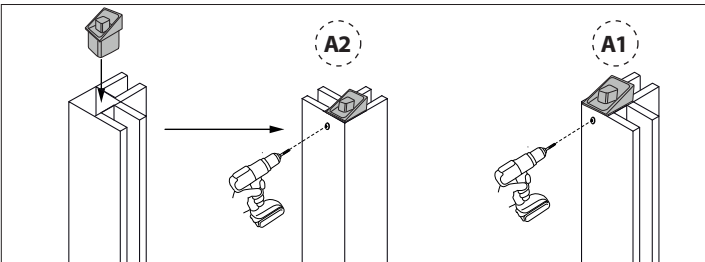

SX



7. ASSEMBLAGGIO TETTO | ROOF ASSEMBLY | MONTAGE DU TOIT | ARMADO DEL TECHO | DACHMONTAGE

-  **M6x14**
6 x

-  **R6**
6 x

-  **M6**
6 x

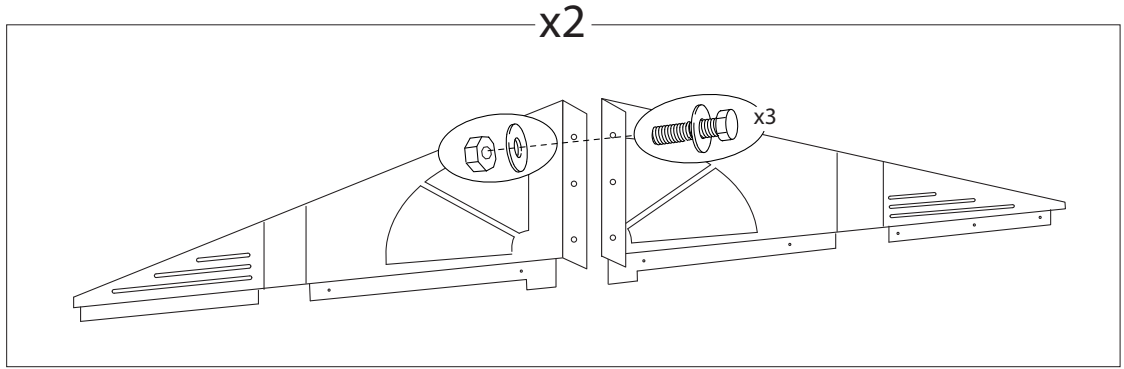

8.

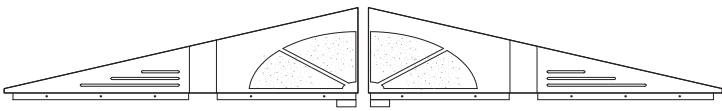

G

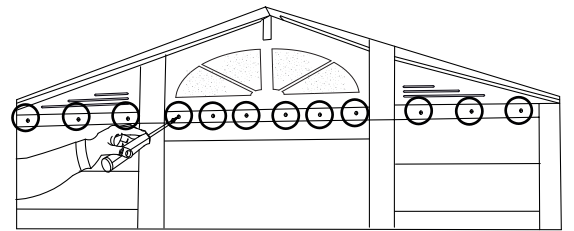

-  **4,5x16**
24 x

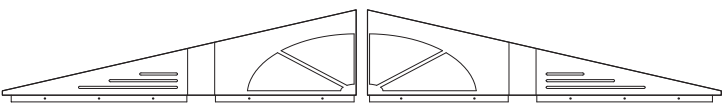

F

RETRO
BACK

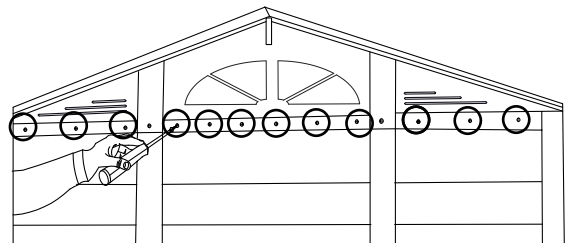
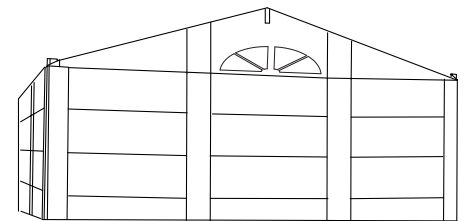

9.

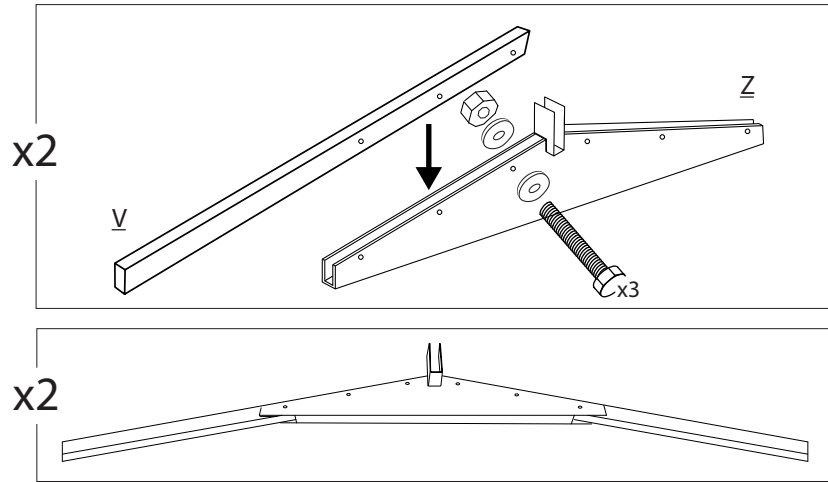
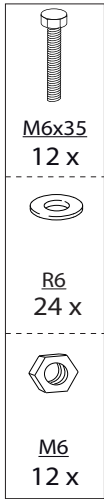

10.

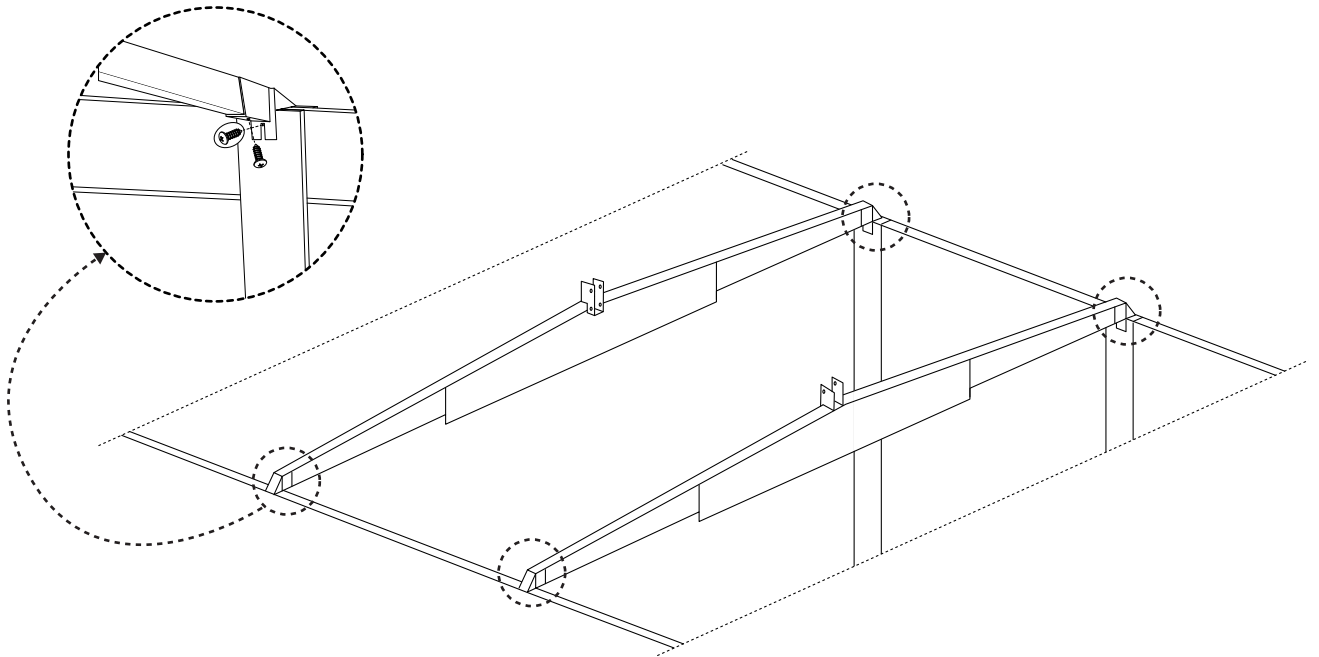
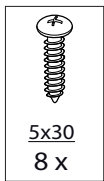

11.

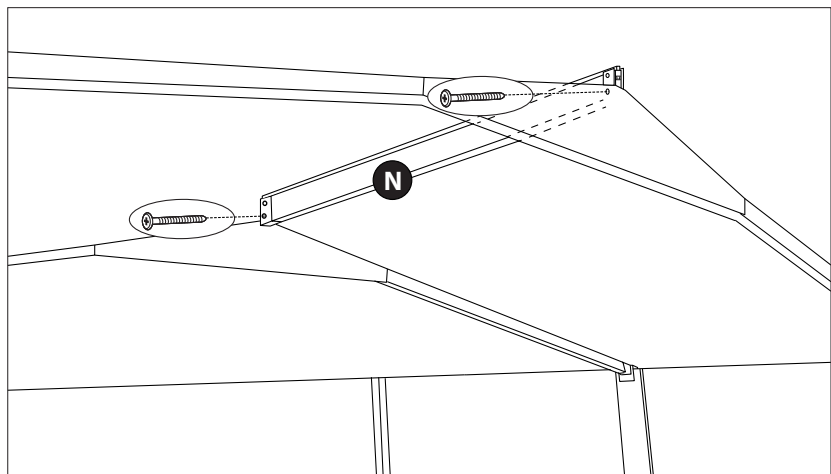
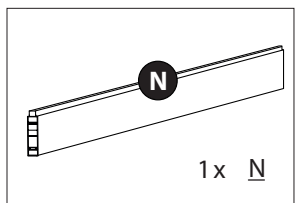
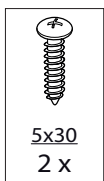

12.

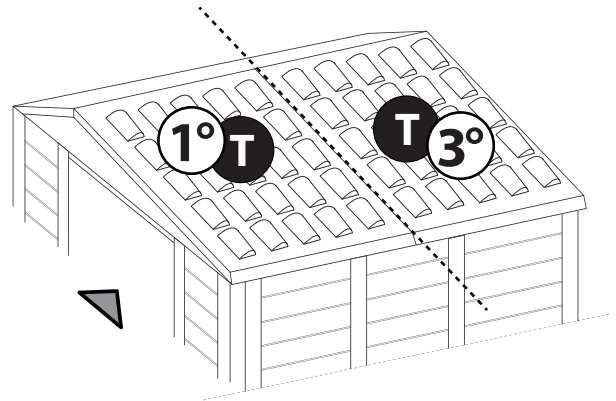
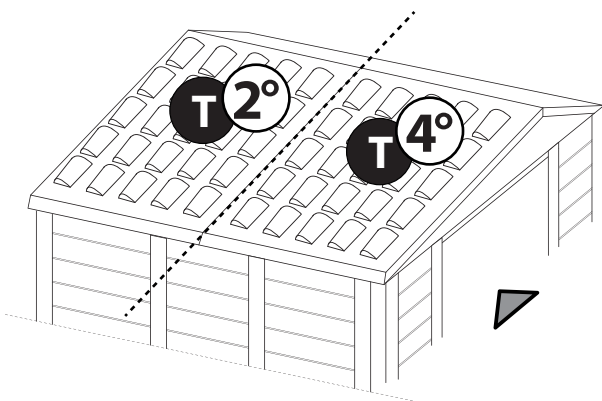
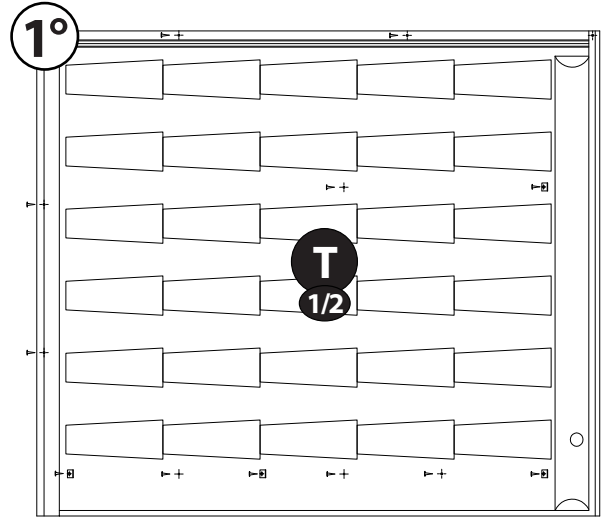
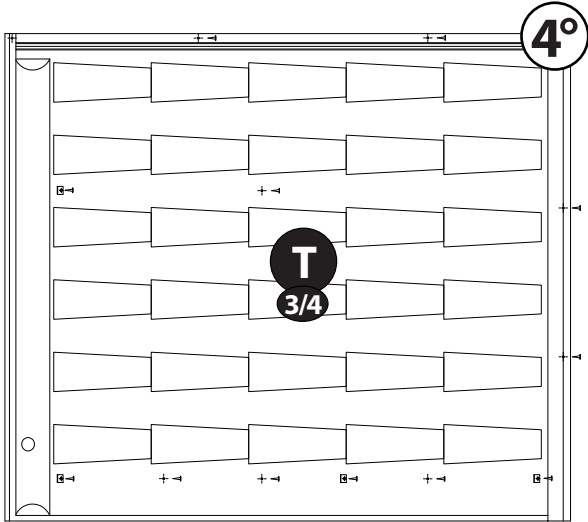
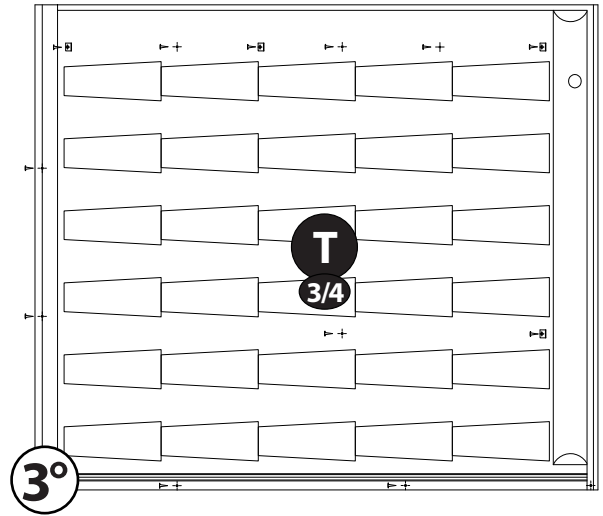
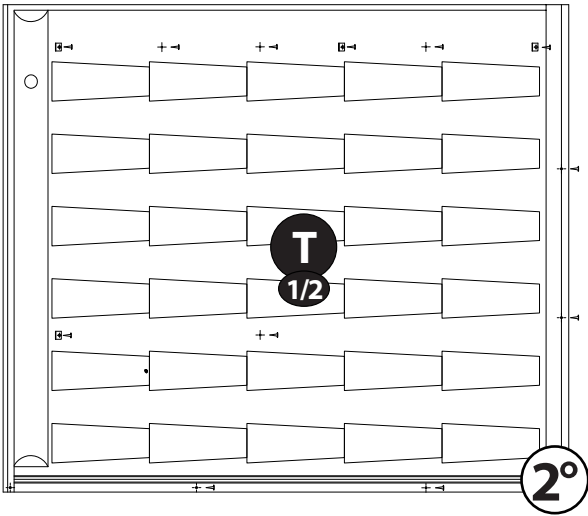

13.

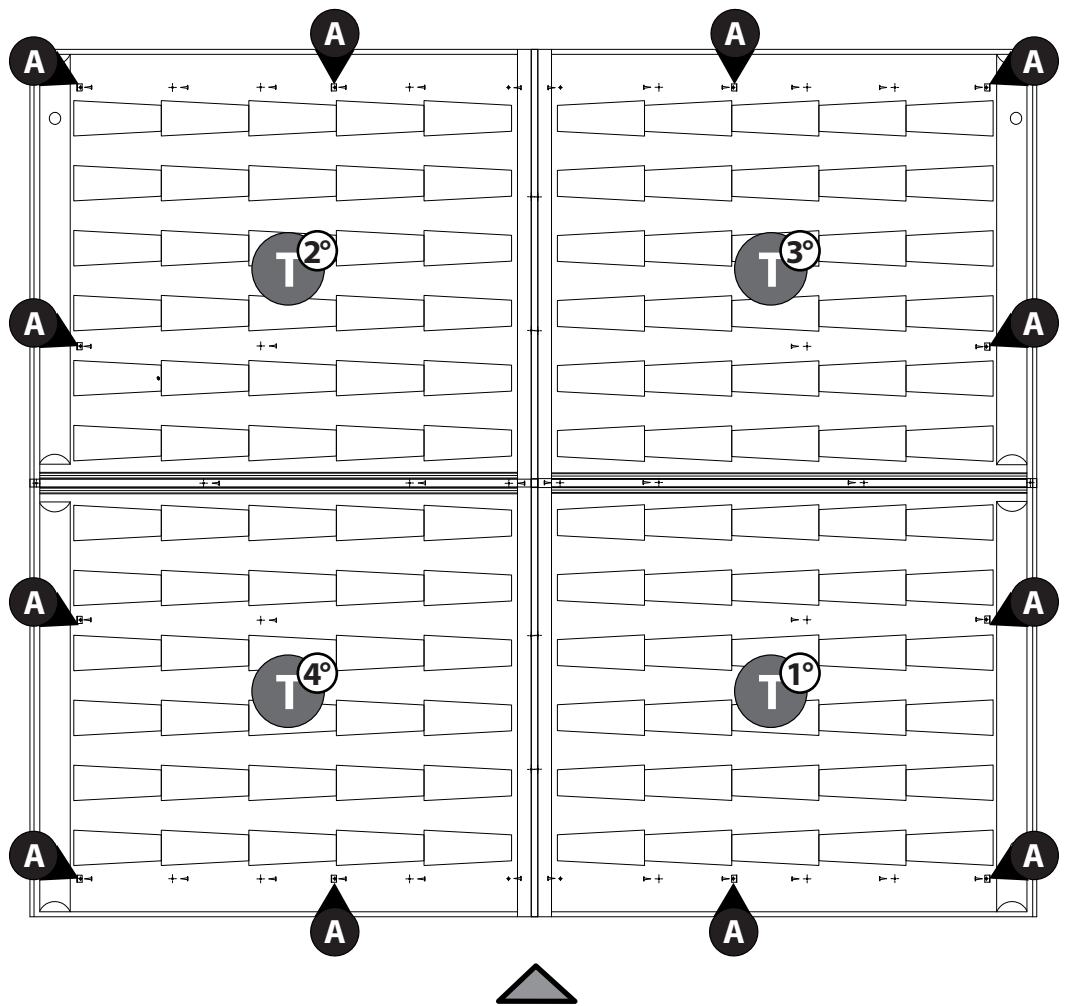
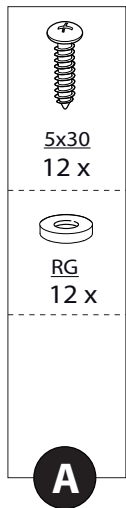

AVVITARE LE VITI (A) SENZA SERRARLE | SCREW THE SCREWS (A) WITHOUT TIGHTENING

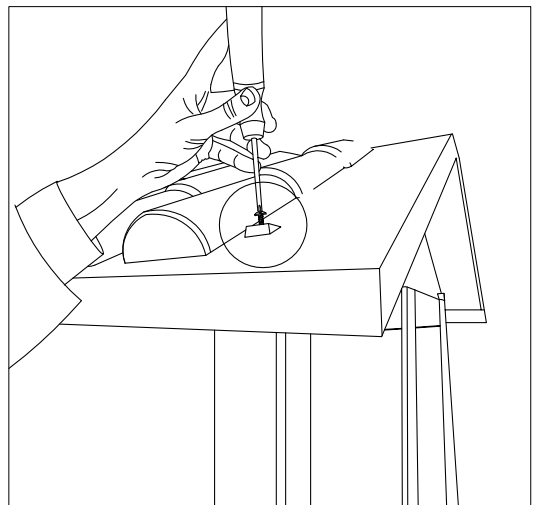
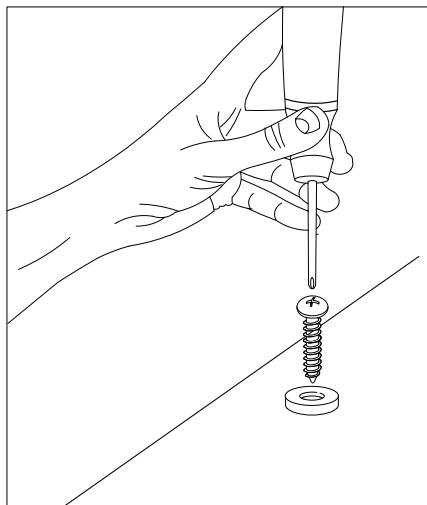



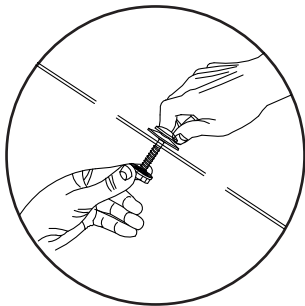
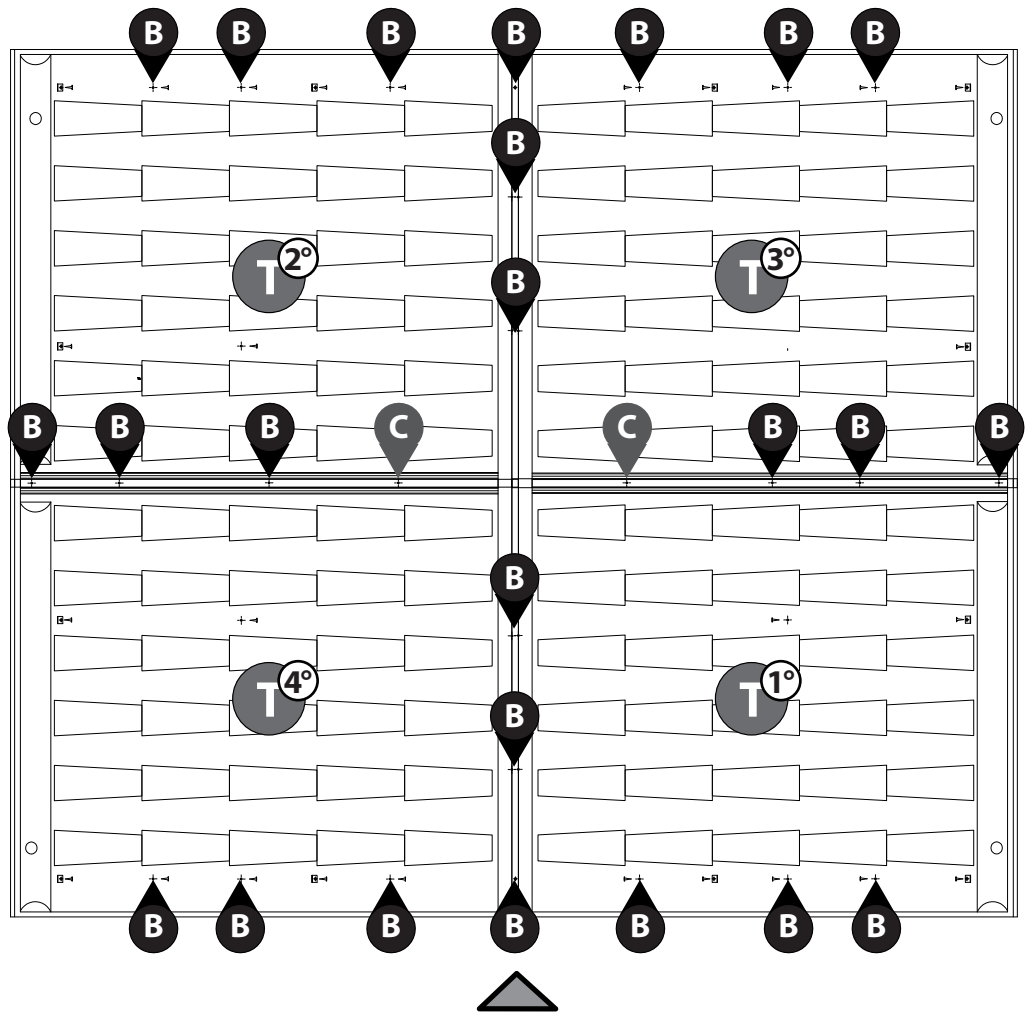
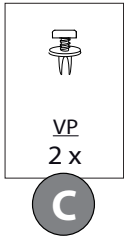
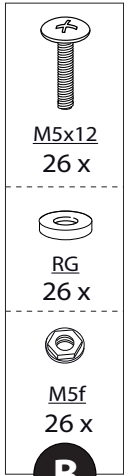



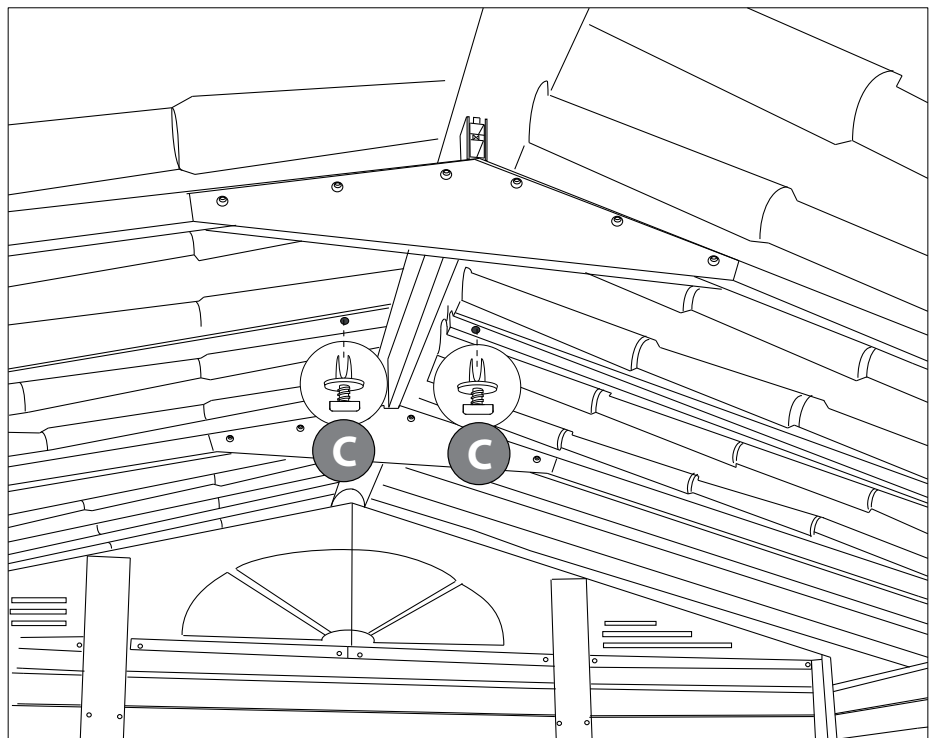

14.

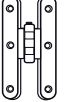

INFINE SERRARE LE VITI (A) | IN THE END TIGHTEN THE SCREWS (A)



15. ASSEMBLAGGIO PORTA | DOOR ASSEMBLY | MONTAGE DE LA PORTE | ARMADO DE LA PUERTA | MONTAGE DER TÜR

	
	
M4x30 6 x	M4x30 24 x
	
R4x16 6 x	R4x16 24 x
	
M4 6 x	M4 24 x
	
TPd 6 x	TPd 24 x

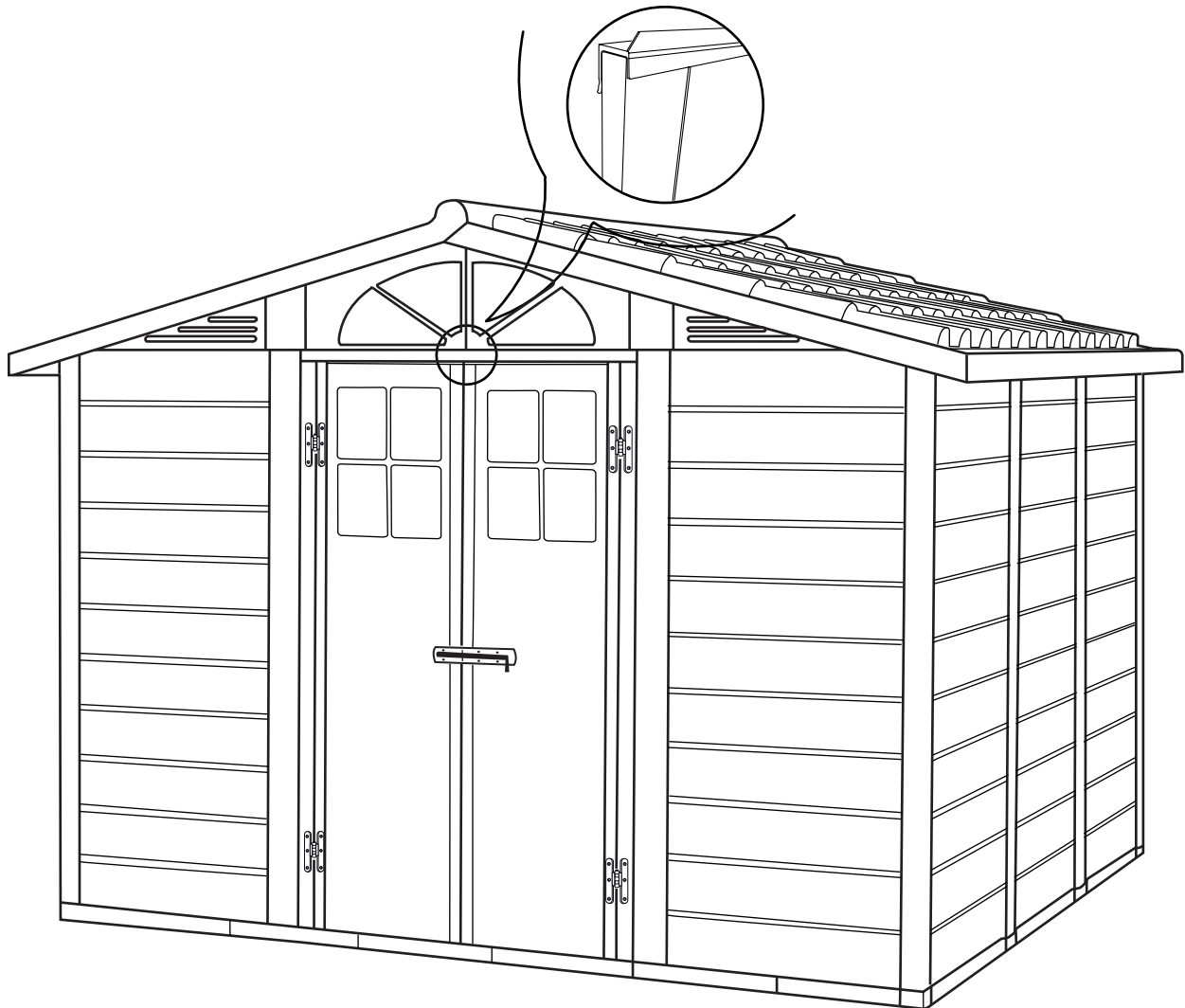
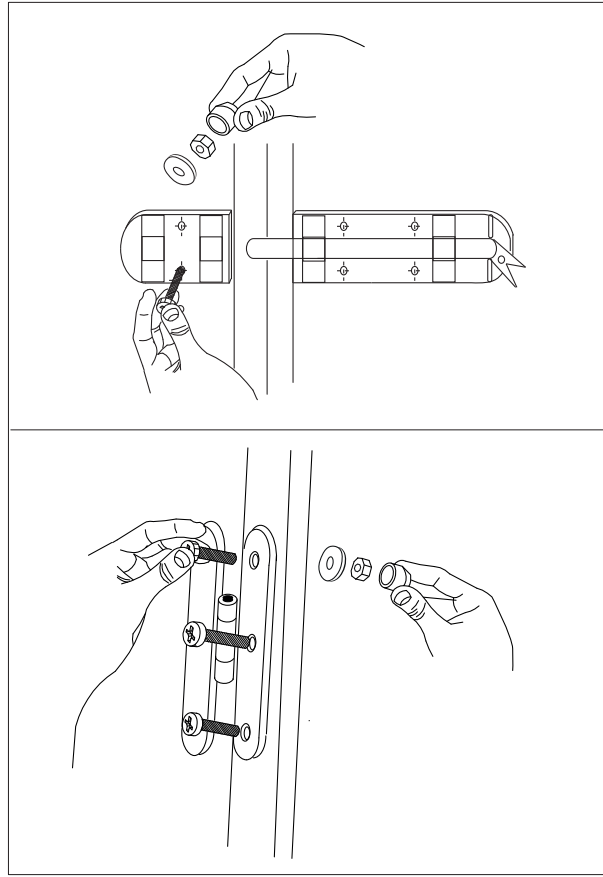

16.

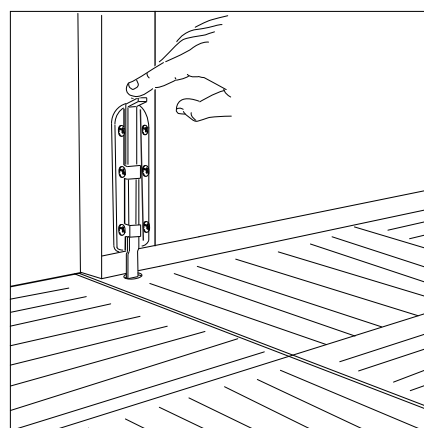
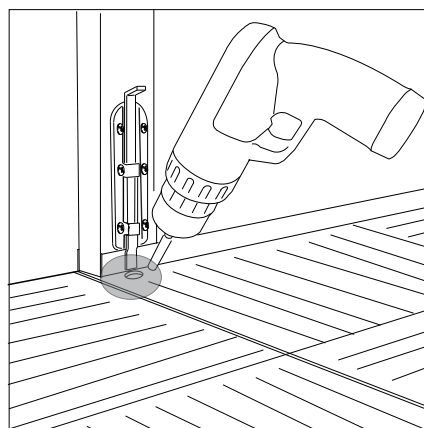
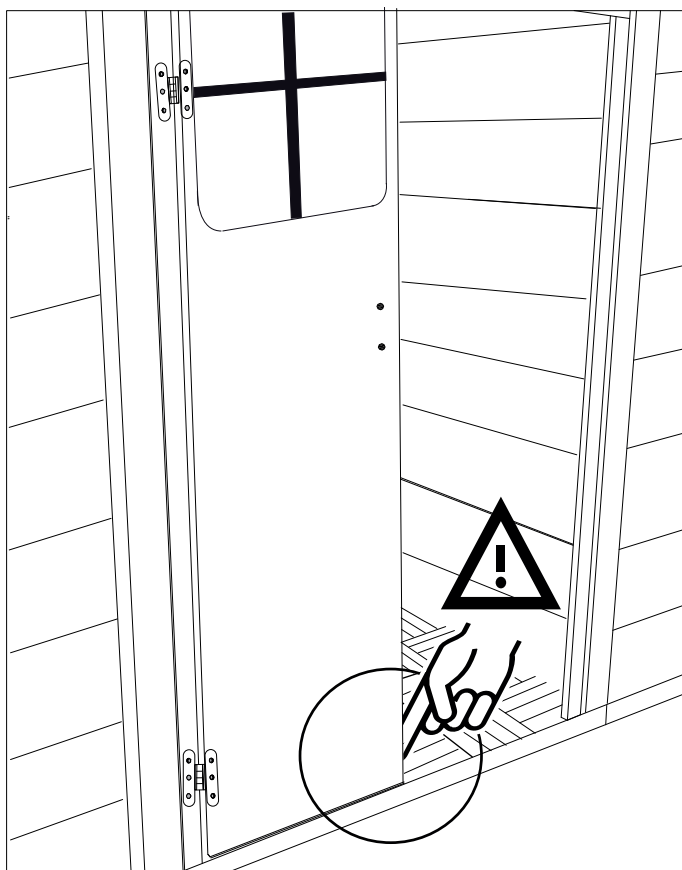
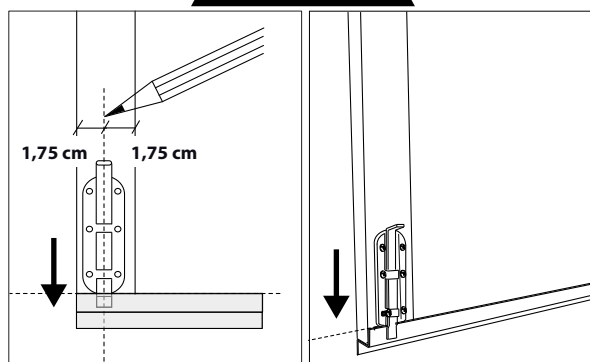
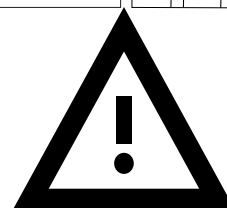
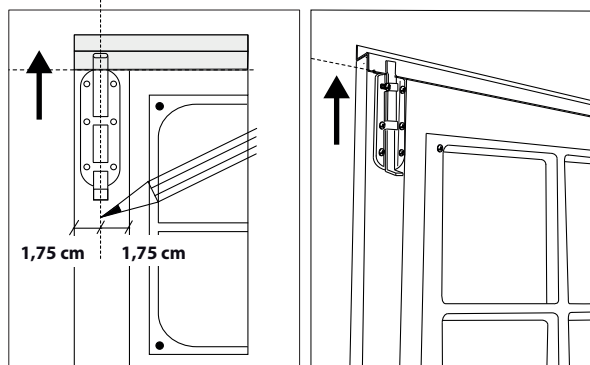
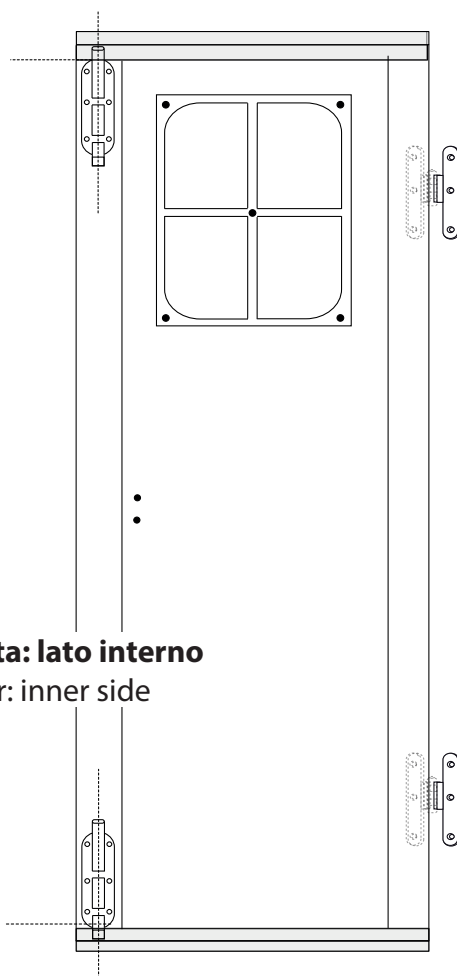
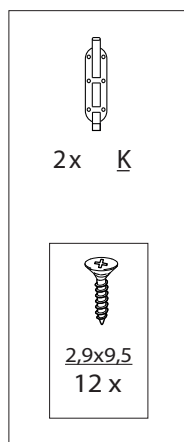



MANUTENZIONE | MAINTENANCE | ENTRETIEN | MANTENIMIENTO | WARTUNGSARBEITEN

- Questo deposito attrezzi non richiede manutenzione. Non sono necessari pittura o vernici.
- This shed is maintenance free. Paint or varnish are not necessary.
- Cet abri ne nécessite aucun entretien. Peindre ou vernir n'est pas nécessaire.
- El cobertizo no necesita mantenimiento. Tampoco hay que pintarlo ni barnizarlo.
- Dieser Schuppen benötigt keine Wartung. Streichen oder Lackieren ist nicht notwendig.

CASSETTE GAROFALO

Questa casetta non richiede manutenzione,

La casetta può essere utilizzata con il colore originario, oppure le pareti possono essere dipinte per adattarsi meglio all'ambiente circostante.

Prima di dipingere:

• Tipo di vernice: le pareti della casetta possono essere dipinte con una vernice acrilica ad acqua per uso esterno. Raccomandiamo: tinta poco diluita, ombreggiature leggere, rifiniture lucide o semi-lucide. Consultare un consulente per verniciature o un imbianchino al momento della scelta della vernice.

• Applicazione: utilizzare un rullo per applicare la vernice sulla superficie delle pareti.

Non dipingere finestre, porte, tetto, pavimento e tutto ciò che non fa parte della struttura in pvc.

Avvertenza: dipingere richiede manutenzione. Dopo qualche tempo potrebbe essere necessaria una ritinteggiatura.

*Per la vostra sicurezza - prima di dipingere assicurarsi di leggere e seguire la cura e la sicurezza della guida della vernice.

GAROFALO SHEDS

This maintenance-free shed is made of a unique compound which enables the brushed wall-panels to be painted.

The shed can be used in its original color, or the walls can be painted to match your landscape, deck, patio, or outdoor setting.

Prior to painting, refer to the detailed care and maintenance instructions:

• Type of paint: The walls of the shed can be painted with a water-based acrylic paint for exterior use. Recommended: Solid, light shades, satin or semi-gloss finish. Consult with your color consultant or paint professional when choosing paint.

• Application: Use a roller to apply the paint on the wall dry surface. Do not paint the beam-like crevices in the walls.

• Do not paint windows, doors, roof, floor or any other part of the shed.

Keep in mind: Painting requires maintenance. After some time, repainting may be required.

* For your safety - make sure you follow the paint's care & safety guide prior to application.

GAROFALO PLACARD

Ce placard n'a pas besoin d'aucun entretien.

Le placard de jardin peut être utilisé dans sa couleur d'origine, ou les murs peuvent être peints pour s'harmoniser avec le paysage, la terrasse, le patio ou les éléments extérieurs. Avant de peindre, consultez les instructions détaillées et le mode d'emploi:

• Type de peinture : les murs de l'abri peuvent être peints avec une peinture acrylique à base d'eau prévue pour l'extérieur. Recommandation: finitions en teintes unies, tons clair satinés ou semi-lustrés. Suivez les indications de votre conseiller ou votre peinture lors de votre choix.

• Application : utilisez un rouleau pour appliquer la peinture sur la surface bien sèche des murs. Ne peignez pas les éléments de support dans les murs.

• Ne peignez ni les fenêtres, ni les portes ou le tour de porte, ni le toit, ni le sol, ni aucun autre élément constituant de l'abri (seulement les murs).

Rappelez-vous : la peinture exige un certain entretien. Après un certain temps, il peut être nécessaire de repeindre.

* Pour votre propre sécurité, suivez bien les instructions d'utilisation de la peinture avant la première application.

CASETA DE GAROFALO

Esta caseta que no requiere mantenimiento, está hecha de un compuesto único que permite pintar las paredes.

La caseta se puede utilizar con su color original o se pueden pintar las paredes para que combinen con el entorno, el patio o los alrededores.

Antes de pintarlo, consulte las instrucciones detalladas de cuidado y mantenimiento:

• Tipo de pintura: Las paredes del cobertizo se pueden pintar con una pintura acrílica de base acuosa para uso en exteriores. Se recomienda: sólida, som-
bras ligeras, satinada o con un acabado de semibrillo. Consulte con su profesional de pinturas cuando vaya a elegir una pintura.

• Aplicación: Utilice un rodillo para aplicar la pintura sobre la superficie seca de la pared. No pinte las hendiduras similares a vigas de las paredes.

• No pinte ventanas, puertas o vigas de la puerta, el suelo o cualquier otra parte del cobertizo. Tenga en cuenta: pintar requiere mantenimiento. Después de algún tiempo podría necesitar otra mano de pintura.

* Para su seguridad, asegúrese de que sigue la guía de cuidado y seguridad de la pintura antes de su aplicación. con el entorno, el patio o los alrededores.

Antes de pintarlo, consulte las instrucciones detalladas de cuidado y mantenimiento:

• Tipo de pintura: Las paredes del cobertizo se pueden pintar con una pintura acrílica de base acuosa para uso en exteriores. Se recomi-
da: sólida, sombras ligeras, satinada o con un acabado de semibrillo. Consulte con su profesional de pinturas cuando vaya a elegir una pintura.

• Aplicación: Utilice un rodillo para aplicar la pintura sobre la superficie seca de la pared. No pinte las hendiduras similares a vigas de las paredes.

• No pinte ventanas, puertas o vigas de la puerta, el suelo o cualquier otra parte del cobertizo. Tenga en cuenta: pintar requiere mantenimiento. Después de algún tiempo podría necesitar otra mano de pintura.

* Para su seguridad, asegúrese de que sigue la guía de cuidado y seguridad de la pintura antes de su aplicación.

GAROFALO SCHRANK

Dieser wartungsfreie Schrank besteht aus einer einzigartigen Verbindung, welches es ermöglicht, die gebürsteten Wandpaneele zu streichen.

Sie können den Schrank in seiner ursprünglichen Farbe nutzen oder dessen Wände streichen, um ihn der Landschaft, Terrasse oder Umgebung anzupas-
sen. Bitte lesen Sie vor dem Streichen die ausführlichen Wartungs- und Pflegehinweise:

• Art der Farbe: Die Wandpaneele können mit einer Acrylfarbe auf Wasserbasis angestrichen werden. Unsere Empfehlung: Solide und helle Farbtöne mit
mattem oder seidenmattem Finish. Sprechen Sie bezüglich Ihrer Farbwahl mit einem Farbberater oder einem professionellen Maler.

• Applikation: Verwenden Sie eine Farbröllen, um die Farbe auf die trockene Wandoberfläche aufzutragen. Bitte streichen Sie nicht die Zwischenräume der
einzelnen Paneele.

• Fenster, Türen, Türträger, Dach, Boden und jegliche andere Teile des Gartenhauses bitte nicht anstreichen!

Bitte beachten Sie: Streichen erfordert Instandhaltung und Pflege. Daher kann nach einiger Zeit ein Neuanstrich erforderlich sein.

*Achtung: Beachten Sie vor dem Streichen die Pflege- und Sicherheitshinweise der Farbe.



LINEE GUIDA PER LA CURA E LA SICUREZZA

- Il prodotto va utilizzato solo per scopi di immagazzinamento. Non è progettato per abitarvi.
- Si raccomanda vivamente di fissare il prodotto su un piano inamovibile o ancorandolo al suolo forando il pavimento ed inserendo viti adeguate nel terreno (le viti non sono incluse).
- Non tentate il montaggio in giornate ventose o fredde.
- Controllate periodicamente il prodotto per accertarvi che sia stabile e che sia a livello del terreno.
- Fate attenzione quando maneggiate parti con bordi in acciaio.
- Durante il montaggio o la manipolazione del prodotto, utilizzate solo gli strumenti elencati nel manuale utente.
- Indossate sempre guanti da lavoro, protezioni per gli occhi e maniche lunghe durante il montaggio o durante la manutenzione
- Evitate di utilizzare un tosaerba o una falce meccanica nei pressi del prodotto stesso.
- Indossate occhiali di sicurezza e seguite sempre le istruzioni del produttore quando utilizzate utensili elettrici.
- Lavate il prodotto con un tubo da giardino o una soluzione detergente delicata. Non utilizzate una spazzola dura o detergenti abrasivi, né sgrassanti e materiali di pulizia per l'olio - o a base di acetone, in quanto questi possono macchiarlo o danneggiarlo.
- Non conservate oggetti caldi, come grill e lampade per saldature né sostanze chimiche evaporabili all'interno del prodotto.
- Evitate di posizionare oggetti pesanti contro le pareti, in quanto ciò potrebbe causare una deformazione del prodotto.
- Mantenete il tetto pulito dalla neve e dalle foglie accumulate. Grandi quantità di neve sul tetto possono danneggiare il prodotto, rendendone precaria la struttura.
- La direzione del vento è un fattore importante da considerare quando scegliete la posizione del prodotto. Riducete l'esposizione al vento, della casetta in generale. In particolare, evitare di esporre le porte al vento.
- Tenete le porte chiuse e bloccate quando il prodotto non è in uso per prevenire i danni del vento.
- Non salite sul tetto.
- Consultate le autorità locali per verificare se sono necessari dei permessi per assemblare il prodotto.

CARE AND SAFETY GUIDELINES

- The shed is intended for storage purposes only. It is not designed for habitation.
- It is strongly recommended to secure the shed to an immovable object or anchor to the ground by drilling holes in the shed floor and inserting proper screws into the ground (screws are not included).
- Do not attempt assembly on windy or cold days.
- Periodically check the shed to ensure that it is stable and that the site is level.
- Be careful when handling parts with steel edges.
- When assembling or handling the shed, use only those tools listed in the user manual.
- Always wear work gloves, safety goggles and long sleeves when assembling or performing any maintenance on your shed.
- Avoid using a lawnmower or mechanical scythe near the shed.
- Wear safety goggles and always follow the manufacturer's instructions when using power tools.
- Wash the shed with a garden hose or a mild detergent solution. Do not use a stiff brush or abrasive cleaners, including degreasers and oil- or acetone-based cleaning materials, as these may stain or damage the shed.
- Do not store hot items, such as recently used grills and blowtorches, and volatile chemicals in the shed.
- Avoid placing heavy items against the walls, as this may cause distortion.
- Keep the roof clear of accumulated snow and leaves. Large amounts of snow on the roof can damage the shed, making it unsafe to enter.
- Wind direction is an important factor to consider when determining the location of the shed. Reduce exposure to the wind, in general, and of the door side in particular. Keep doors closed and locked when the shed is not in use to prevent wind damage.
- Do not stand on the roof.
- Consult your local authorities to check if permits are required to erect the shed.

INSTRUCTIONS DE SÉCURITÉ ET D'ENTRETIEN

- L'abri a été conçu uniquement à des fins de stockage. Il n'a pas été conçu à des fins d'habitation.
- Il est fortement recommandé de sécuriser l'abri à un objet inamovible ou de le fixer au sol en creusant des trous dans le sol de l'abri (aux emplacements marqués) et d'insérer les vis adaptées dans le sol (vis non incluses).
- N'essayez pas de réaliser le montage par jour venteux ou froid.
- Vérifiez de temps en temps la tenue de l'abri afin de garantir sa stabilité et la mise à niveau du site, sur lequel il est posé.
- Manipulez les pièces présentant des bords en acier avec précaution.
- Lors de l'assemblage ou de la manipulation de l'abri, utilisez seulement les outils listés dans le mode d'emploi.
- Portez toujours des gants de travail, des lunettes de protection et des vêtements à manches longues lors de l'assemblage ou de l'accomplissement d'activités de maintenance sur votre abri.
- Évitez d'utiliser une tondeuse à gazon ou une faux mécanique à proximité de l'abri.
- Portez des lunettes de sécurité et suivez toujours les instructions du fabricant lors de l'utilisation d'outils électriques.
- Lavez l'abri à l'aide d'un tuyau d'arrosage de jardin ou d'un détergent non abrasif. N'utilisez pas une brosse dure ou de nettoyeurs abrasifs, y compris les dégraissants et les solutions de nettoyage à base d'acétone ou d'huile, car ils peuvent tacher ou endommager l'abri.
- Ne stockez pas d'objets chauds, tels qu'un grill ou un chalumeau récemment utilisé, ou des produits chimiques volatils dans l'abri.
- Évitez de placer des objets lourds contre les murs de votre abri, cela peut entraîner une déformation.
- Entretenez le toit pour éviter l'accumulation de neige ou de feuilles. Une grande quantité de neige sur le toit peut endommager l'abri, rendant périlleux l'accès à l'intérieur.
- La direction du vent est un facteur important à prendre en compte lors du choix de la localisation de l'abri. Réduisez l'exposition au vent, en général, et surtout pour le côté de la porte. Maintenez les portes fermées et verrouillées lorsque l'abri n'est pas utilisé, afin d'éviter tout dégât dû au vent.
- Ne montez pas sur le toit.
- Consultez les autorités de votre localité pour vérifier la nécessité de disposer d'un permis pour ériger l'abri.

ADVERTENCIA SOBRE EL CUIDADO Y LA SEGURIDAD

- La cobertizo está diseñada solo para el almacenamiento de productos. No está diseñada para habitar en ella.
- Se recomienda encarecidamente fijar la cobertizo a un objeto inamovible o anclarla al suelo taladrando agujeros en el suelo de la cobertizo (en los lugares premarcadas para ello), e insertando tornillos adecuados en el suelo (los tornillos no están incluidos).
- No intente montarlo en días de viento o cuando haga frío.
- Compruebe la cobertizo periódicamente para asegurarse de que es estable y de que el lugar es uniforme.
- Tenga cuidado al manejar las partes con bordes de acero.
- Al montar o manipular la cobertizo, use solamente las herramientas enumeradas en el manual del usuario.
- Use siempre guantes de trabajo, anteojos protectores y mangas largas para armar el cobertizo o realizar cualquier tarea de mantenimiento en el mismo.
- Evite usar un cortacésped o un cortacésped cerca de la cobertizo.
- Lleve gafas de seguridad y siga siempre las instrucciones del fabricante al utilizar herramientas eléctricas.
- Lave la cobertizo con una manguera de jardín o con un detergente suave. No utilice un cepillo rígido ni limpiadores abrasivos, incluyendo desengrasantes y materiales de limpieza basados en petróleo o acetona, ya que todos ellos pueden manchar o dañar la cobertizo.
- No guarde objetos calientes, como sopletes usados recientemente, ni elementos químicos volátiles.
- Evite situar objetos pesados contra las paredes, ya que esto puede causar deformación.
- Mantenga el techo limpio de nieve y hojas acumuladas. Una gran cantidad de nieve en el tejado puede dañar el cobertizo, haciendo que sea inseguro entrar.
- La dirección del viento es un factor importante a tener en cuenta al determinar la ubicación del cobertizo. Reduzca la exposición al viento en general y al lateral de la puerta en particular. Mantenga las puertas cerradas y bloqueadas cuando no utilice el cobertizo para evitar daños del viento.
- Ne montez pas sur le toit.
- Consulte con sus autoridades locales y son necesarios No se ponga de pie sobre el techo. permisos para levantar el cobertizo.

PFLEGE - UND SICHERHEITSHINWEISE

- Der Gartenschuppen dient einzig und allein der Lagerung von Gegenständen. Der Schuppen ist nicht für Wohnzwecke ausgelegt.
- Es wird dringend empfohlen, den Schuppen an einem unbeweglichen Gegenstand zu befestigen oder Mithilfe von Löchern im Schuppenboden im Boden zu verankern, wobei geeignete Schrauben zu verwenden sind (Schrauben sind nicht im Lieferumfang enthalten).
- Führen Sie den Aufbau nicht an windigen oder kalten Tagen durch.
- Überprüfen Sie den Schuppen regelmäßig auf Stabilität und stellen Sie sicher, dass der Standort eben ist.
- Seien Sie vorsichtig, wenn Sie mit Teilen hantieren, die Stahlkanten aufweisen.
- Für Aufbau und Handhabung des Schuppens verwenden Sie bitte nur Werkzeuge, die in der Aufbauanleitung aufgelistet sind. • Tragen Sie bei der Montage des Gartenschuppens oder Wartungsarbeiten stets Arbeitshandschuhe, eine Schutzbrille und Kleidungsstücke mit langen Ärmeln
- Vermeiden Sie den Einsatz von Rasenmäher und maschineller Sense im direkten Umfeld des Schuppens.
- Tragen Sie eine Schutzbrille und befolgen Sie bei Verwendung von Elektrowerkzeugen immer die Anweisungen des Herstellers.
- Reinigen Sie den Schuppen mit einem Gartenschlauch und einem milden Reinigungsmittel. Verwenden Sie auf keinen Fall eine harte Bürste und Scheuer- oder Entfettungsmittel sowie Öl- oder Acetonhaltige Reinigungsmittel, da diese Flecken verursachen oder den Schuppen beschädigen könnten.
- Lagern Sie keine heißen Gegenstände im Schuppen, wie etwa kürzlich benutzte Grills oder Lötlampen und auch keine flüchtigen Chemikalien.
- Lehnen Sie keine schweren Gegenstände an die Wände des Schuppens, da sich dadurch der gesamte Schuppen verziehen könnte.
- Halten Sie das Dach frei von Schnee und angesammeltem Blattwerk. Große Mengen an Schnee können den Schuppen beschädigen und beim Betreten gefährlich werden.
- Die Windrichtung ist ein wichtiger Faktor, der bei der Aufstellung des Schuppens unbedingt berücksichtigt werden muss. Vermeiden Sie zu hohe Windbelastungen, insbesondere einen hohen Winddruck auf die Türen. Halten Sie die Türen immer geschlossen und verriegelt, wenn der Schuppen nicht genutzt wird, um eine Beschädigung durch Windbelastungen zu vermeiden.
- Betreten Sie auf keinen Fall das Dach des Schuppens.
- Wenden Sie sich bitte an Ihre lokale Behörde und erkundigen Sie sich dort, ob zum Aufbau des Schuppens eine Genehmigung erforderlich ist.



GARANZIA DI 2 ANNI

Questa garanzia copre il guasto del prodotto dovuto a difetti di fabbricazione o dei materiali per un tempo di 2 anni dalla data di acquisto originale. (Il termine "difetti" è definito come imperfezioni che compromettono l'uso del prodotto).

Questa garanzia non copre i difetti derivanti da normale usura, inclusi, ma non limitati a, sfregamento, graffi o fratture creati durante l'uso, scolorimento, ruggine, uso irragionevole, abuso, negligenza, alterazione, pittura, movimento, trasporto o spostamento del prodotto, "eventi naturali", tra cui, ma non limitati a, grandine, qualsiasi tipo di tempeste, inondazioni e incendi e danni conseguenti o accidentali.

L'assemblaggio e la manipolazione non in conformità con le raccomandazioni, le linee guida e le restrizioni descritte nel manuale utente del prodotto ed il loro utilizzo per applicazioni commerciali o pubbliche renderà nulla questa garanzia.

Garafalo non è responsabile per eventuali danni subiti da consumatore e/o terzi o per danni o smarrimenti di oggetti all'interno o nei pressi delle cassette.

Dopo aver esibito la prova di acquisto (scontrino fiscale) ed esposto, tempestivamente, via mail la prova del problema del prodotto (breve descrizione ed integrazione fotografica), Garafalo, a sua esclusiva discrezione, sostituirà le parti difettose del prodotto, o rimborserà una parte proporzionale del prezzo di acquisto, il valore si deprezzerà del 10% ogni anno.

WARRANTY TWO YEARS

This warranty covers product failure resulting from defects in manufacturing or materials for two year from the date of original retail purchase. (The term "defects" is defined as imperfections that impair the use of the Product).

This warranty does not cover defects resulting from normal wear and tear, including, but not limited to, scuffing, scratches or fractures caused during use, discoloration or fading, rusting, unreasonable use, abuse, negligence, alterations, painting, moving, transporting or relocating the Product, "acts of Nature," including, but not limited to, hail, any type of storm, flood and fire, and consequential or incidental damages.

Assembly and handling not in accordance with the recommendations, guidelines and restrictions as described in the Product's user manual, and usage for commercial or public applications, will void this warranty.

Garafalo is not responsible for any damage incurred by consumer and/or third parties or damage to or loss of objects inside or near the shed.

Upon submitting proof of purchase and evidence of the claimed product failure, and subject to reporting the failure in a timely manner, Garofalo, at its sole discretion, will replace defective parts of the Product, or refund you a prorated portion of the purchase price on a straight line depreciated basis, the value will depreciate 10% each year.

GARANTIE DEUX ANS

Cette garantie couvre les dommages du produit découlant d'un défaut de fabrication ou des matériaux pour une durée de 2 ans à partir de la date d'achat. (Le terme « défaut » est défini comme des imperfections qui nuisent à la bonne utilisation du produit).

Cette garantie ne couvre pas les défauts résultant d'une usure normale, y compris, mais non limitée aux rayures, aux éraflures ou aux bris provoqués par l'utilisation, la décoloration ou l'estompement de la couleur, la rouille, l'utilisation déraisonnable, les abus, la négligence, les altérations, la peinture, les déplacements, le transport ou la relocalisation du produit, les « conditions climatiques exceptionnelles », y compris, mais non limitée à, la grêle, tout type de tempête, les inondations et incendies, et tous dégâts accidentels ou consécutifs qui y seraient liés.

Un assemblage et une manipulation non conformes aux recommandations, aux instructions et aux restrictions, telles que décrites dans le mode d'emploi du Produit, ainsi que l'utilisation à des fins commerciales ou publiques, annuleront cette garantie.

Garofalo ne saurait être tenu responsable de tout dégât encouru par le consommateur et/ou une tierce partie ou de tout dégât ou perte d'objets à l'intérieur ou à proximité de l'abri.

Après avoir fourni une preuve d'achat et une preuve du dommage sur le produit détérioré, et à condition d'avoir signalé le dommage dans les délais impartis, Garofalo, à son absolue discrétion, remplacera les pièces défectueuses du Produit ou vous remboursera une partie du prix d'achat au prorata, amorti sur une base linéaire. La valeur se dépréciera de 10% chaque année.

Nous garantissons la fourniture des pièces détachées durant 2 ans à compter de l'achat du produit.

GARANTÍA DOS AÑOS

Esta garantía cubre fallas de producto por defectos de fabricación o de materiales durante un período de 2 años desde la fecha de la compra del producto. (El término "defectos" se define como imperfecciones que afectan al uso del Producto).

Esta garantía no cubre defectos resultantes por el desgaste debido al uso, incluyendo, entre otros, arañazos, rasguños o roturas provocados durante su uso, decoloración, oxidación, uso no razonable, maltrato, negligencia, alteraciones, pintado, mover, transportar o reubicar el Producto, "causas climatológicas", incluyendo, entre otros, granizo, cualquier tipo de tormenta, inundación e incendio y daños resultantes o accidentales.

El montaje y su manipulación sin seguir las recomendaciones, directrices y restricciones como se describen en el manual del usuario del Producto y su uso para aplicaciones comerciales o públicas anularán esta garantía. Garofalo no se hace responsable por ningún daño realizado por consumidor o terceros o daños o pérdida de objetos dentro o cerca de la caseta. Al entregar el ticket o factura de compra y prueba del presunto fallo del producto, y sujeto a informar del fallo de manera puntual, Garofalo, a su discreción, reemplazará las piezas defectuosas del Producto o le reembolsará una parte prorrateada proporcional del precio de compra en función, el valor se depreciará un 10% cada año.

GARANTIE ZWEI JAHRE

Die garantie Zeit umfasst Herstellungs- oder Materialdefekte am Produkt und gilt ab dem Datum des ursprünglichen Erwerbs Zeitraum von 2 Jahren (Der Begriff „Defekte“ wird definiert als Beeinträchtigungen, die die Nutzung des Produktes herabsetzen).

Diese Gewährleistung umfasst keine Defekte, die aus normalem Gebrauch resultieren und schließen unter anderem durch die Nutzung des Produktes entstandenen Abrieb, Kratzer oder Risse mit ein sowie Verfärbungen, Rostansatz und Schäden aufgrund von unsachgemäßer Nutzung, Missbrauch, Unachtsamkeit,

Abänderungen, Bemalen, das Versetzen oder Transportieren des Produktes und „Naturereignisse“, wozu unter anderem Hagelschlag, jegliche Form von Sturm, Flut und Feuer zählen sowie mittelbare und damit verbundene Beschädigungen hierdurch.

Bei Aufbau und Handhabung, die nicht gemäß den Empfehlungen, Vorgaben und Beschränkungen durchgeführt werden, wie sie in der Gebrauchsanleitung zu dem Produkt vermerkt sind, verliert diese Gewährleistung ihre Gültigkeit. Dies gilt auch für einen Gebrauch zu kommerziellen und öffentlichen Zwecken.

Garofalo ist nicht verantwortlich für Beschädigungen durch Kunde und/oder Dritte und Schäden an und Verlust von Gegenständen innerhalb oder in der Nähe des Schuppens.

Nach der Einreichung von Kaufnachweis und Beweismaterial für den beanstandeten Defekt am Produkt, vorbehaltlich einer zeitnahen Meldung des Defekts, wird Garofalo während der gesamten Gewährleistungsdauer nach alleinigem Ermessen fehlerhafte Teile austauschen oder einen anteiligen Betrag des Kaufpreises auf Basis der linearen Abschreibung zurückerstatten, der Wert vermindert sich jährlich um 10%.



Per assistenza al montaggio, o per richiedere pezzi di ricambio, accedi al nostro sito nell'area contatti, scrivi un'email a help@garofalofirenze.it oppure chiama il numero +39 055. 898281

NON RSTITUIRE IL PRODOTTO AL NEGOZIO.

For assistance with assembly, or to request replacement parts, access our website in the contact area, write an email to help@garofalofirenze.it or call +39 055. 898281

DO NOT RETURN THE PRODUCT TO THE STORE.

Si vous avez besoin d'aide pour le montage, ou pour demander des pièces de rechange, accédez à notre website dans la zone de contact, écrivez un email à help@garofalofirenze.it, or call +39 055. 898281

NE RETOURNEZ PAS LE PRODUIT AU MAGASIN.

Para obtener ayuda sobre el montaje o para solicitar piezas de repuesto, conéctese a nuestro website en el área de contacto, escriba un correo electrónico a help@garofalofirenze.it o llamar +39 055. 898281

NO DEVUELV A EL PRODUCTO A LA TIENDA.

Wenn Sie Hilfe beim Aufbau oder Ersatzteile benötigen, greifen Sie auf unsere Website im Kontaktbereich zu und schreiben Sie eine E-Mail an help@garofalofirenze.it oder anrufen +39 055. 898281

GEBEN SIE DAS PRODUKT NICHT IM GESCHÄFT ZURÜCK.

garofalo 
SEMPLICI IDEE D'ARREDO

MADE IN ITALY

G. & S. GAROFALO S.A.S.

Via del Biancospino, 19
Campi Bisenzio (FI), 50013 - ITALY
tel. +39 055 898281 / 2
fax +39 055 8969013
email: info@garofalofirenze.it

www.garofalofirenze.it

Follow
Garofalo Firenze



M05.04.153 - 08/2021